

# WaveCAST EIGHT

Multichannel Assistive Listening System WF T8

USER MANUAL



# Table of Contents

---

<b>Safety Warnings and Instructions</b> .....	<b>4</b>
<b>Recycling Instructions</b> .....	<b>5</b>
<b>System Overview</b> .....	<b>5</b>
<b>Quick Setup Instructions</b> .....	<b>6</b>
<b>Wi-Fi Network Required</b> .....	<b>7</b>
<b>Router and Network Equipment Selection</b> .....	<b>7</b>
<b>Network and Power Connections</b> .....	<b>7</b>
Power Supply Connection.....	<b>7</b>
Network Connection.....	<b>7</b>
<b>System Settings</b> .....	<b>7</b>
Network Configuration.....	<b>8</b>
Adjusting Network Settings.....	<b>8</b>
Audio Settings.....	<b>8</b>
Audio Input Source.....	<b>8</b>
Audio Input Gain.....	<b>8</b>
Audio Presets.....	<b>8</b>
Server Description.....	<b>9</b>
Channel Description.....	<b>9</b>
Restore Defaults.....	<b>9</b>
<b>Web Control Interface</b> .....	<b>9</b>
Login Page.....	<b>9</b>
Changing Channels.....	<b>10</b>
Main Settings Page.....	<b>10</b>
Options Page.....	<b>11</b>
Server Settings Page.....	<b>12</b>
Upload Image.....	<b>13</b>
Administration Page.....	<b>13</b>
<b>Manual Controls and Features</b> .....	<b>14</b>
Power Button.....	<b>14</b>
OLED Display.....	<b>14</b>
Audio Input Level Indicator.....	<b>14</b>

Input Overload Indication.....	14
Multiple WaveCAST EIGHT Units.....	14
Main Info Screen.....	14
Navigating the Front Panel.....	14
Screen Time Out.....	14
<b>Front Panel Interface.....</b>	<b>14</b>
Main Menu.....	14
Restoring Defaults.....	15
Locking the Front Panel.....	15
Channel Menu.....	15
<b>Audio Source Connections.....</b>	<b>16</b>
Wiring Connections.....	16
Selecting an Audio Source Appropriate for Hearing Impaired Listeners.....	17
Connecting to other Devices.....	17
<b>WaveCAST App.....</b>	<b>18</b>
Connect to Wi-Fi Network.....	18
Connecting the App to the Channel.....	18
Listening via the App.....	18
Note on Wi-Fi Assist/Smart Network Switching.....	18
<b>Troubleshooting.....</b>	<b>19</b>
Ethernet Light Troubleshooting.....	19
Website problems.....	19
Audio problems.....	19
Reception or App difficulties.....	19
Device is not working over the hardwired Ethernet network.....	20
Device is not working over Wi-Fi.....	21
Checking Software Versions.....	21
<b>Specifications.....</b>	<b>22</b>
<b>2-Year Warranty.....</b>	<b>22</b>
<b>Regulatory Statements.....</b>	<b>24</b>
FCC.....	24
IC.....	25

## Safety Warnings and Instructions

---

**WARNING!** TO REDUCE THE RISK OF FIRE OR ELECTRIC SHOCK, DO NOT EXPOSE THIS APPLIANCE TO RAIN OR MOISTURE.

**CAUTION!** TO REDUCE THE RISK OF ELECTRIC SHOCK, DO NOT REMOVE COVER. NO USER-SERVICEABLE PARTS INSIDE. REFER SERVICING TO QUALIFIED SERVICE PERSONNEL.

**POWER CORD NOTICE FOR INTERNATIONAL OPERATION** - Please call Williams AV Customer Service at +1-952-943-2252 to order the appropriate power cord for the country of use.

### Important Safety Instructions:

1. Read and follow these instructions
2. Keep these instructions
3. Clean only with dry cloth.
4. Do not block any ventilation openings. Install in accordance with the manufacturer's instructions.
5. Do not install near any heat sources such as radiators, heat registers, stoves, or other appliance (including amplifiers) that produce heat.
6. Do not defeat the safety purpose of the polarized or grounding-type plug. A polarized plug has two blades with one wider than the other. A grounding type plug has two blades and a third grounding prong. The wide blade or the third prong is provided for your safety. If the provided plug does not fit into your outlet, consult an electrician for replacement of the obsolete outlet.
7. Protect the power cord from being walked on or pinched particularly at plugs, convenience receptacles, and the point where they exit from the appliance.
8. Only use attachments/accessories specified by the manufacturer.
9. Unplug this appliance during lightning storms or when unused for long periods of time.
10. Power Sources - The appliance should be connected to a power supply only of the type described in the operating instructions or as marked on the appliance.
11. Object and Liquid Entry - Care should be taken so that objects do not fall and liquids are not spilled into the enclosure through the openings. Do not use this appliance near water or expose it to liquids.
12. Servicing - The user should not attempt to service the appliance beyond that described in the operating instructions. All other servicing should be referred to qualified service personnel.

### Precautions:

1. Power – WARNING, BEFORE TURNING ON THE POWER FOR THE FIRST TIME, READ THE FOLLOWING SECTION CAREFULLY. The unit is designed for use only with the line cord of the region in which it will be operated.
2. Voltage Label (Rear Panel) – A label located at the rear panel power connection indicates the DC power input for the unit. The label will read 24VDC. Note: use the Williams AV TFP 062 power supply for this unit.
3. Do Not Plug in the input, output, or Ethernet connections while the power switch is switched to the ON position.
4. Do Not Touch the WaveCAST EIGHT with wet hands. Do not handle the WaveCAST EIGHT or power cord when your hands are wet or damp. If water or any other liquid enters the WaveCAST EIGHT cabinet, take the WaveCAST EIGHT to qualified service personnel for inspection.
5. Place the WaveCAST EIGHT in a well ventilated location. Take special care to provide plenty of ventilation on all sides of the WaveCAST EIGHT especially when it is placed in an audio rack. If ventilation is blocked, the WaveCAST EIGHT may over heat and malfunction. Do not expose the WaveCAST EIGHT to direct sun light or heating units as the WaveCAST EIGHT internal components temperature may rise and shorten the life of the components. Avoid damp and dusty places.
6. Care – From time to time you should wipe off the front and side panels and the cabinet with a soft cloth. Do not use rough material, thinners, alcohol or other chemical solvents or cloths since this may damage the finish or remove the panel graphics.

## Recycling Instructions

Help Williams AV protect the environment! Please take the time to dispose of your equipment properly.



### Product Recycling:

Please do NOT dispose of your equipment in the household trash. Please take the equipment to a electronics recycling center for proper disposal.



### Battery Recycling:

Please do NOT dispose of used batteries in the household trash. Please take the batteries to a retail or community collection point for recycling.

## System Overview

WaveCAST EIGHT is the new, multi-channel Wi-Fi assistive listening platform designed for larger assistive listening applications -- providing the ability to link four WaveCAST EIGHT units for expansion up to 32 channels.

The WaveCAST EIGHT is designed for pro-audio applications where high-quality sound is required for streaming multi-channel audio in real time to smartphones and/or tablets. It is built on a hardware-based DSP audio system architecture, allowing system optimization to achieve the highest quality experience for the particular audio stream being delivered.

**Note that these instructions only apply to the WaveCAST EIGHT and do not apply to other WaveCAST systems, including the WaveCAST EIGHT D with Dante features.**

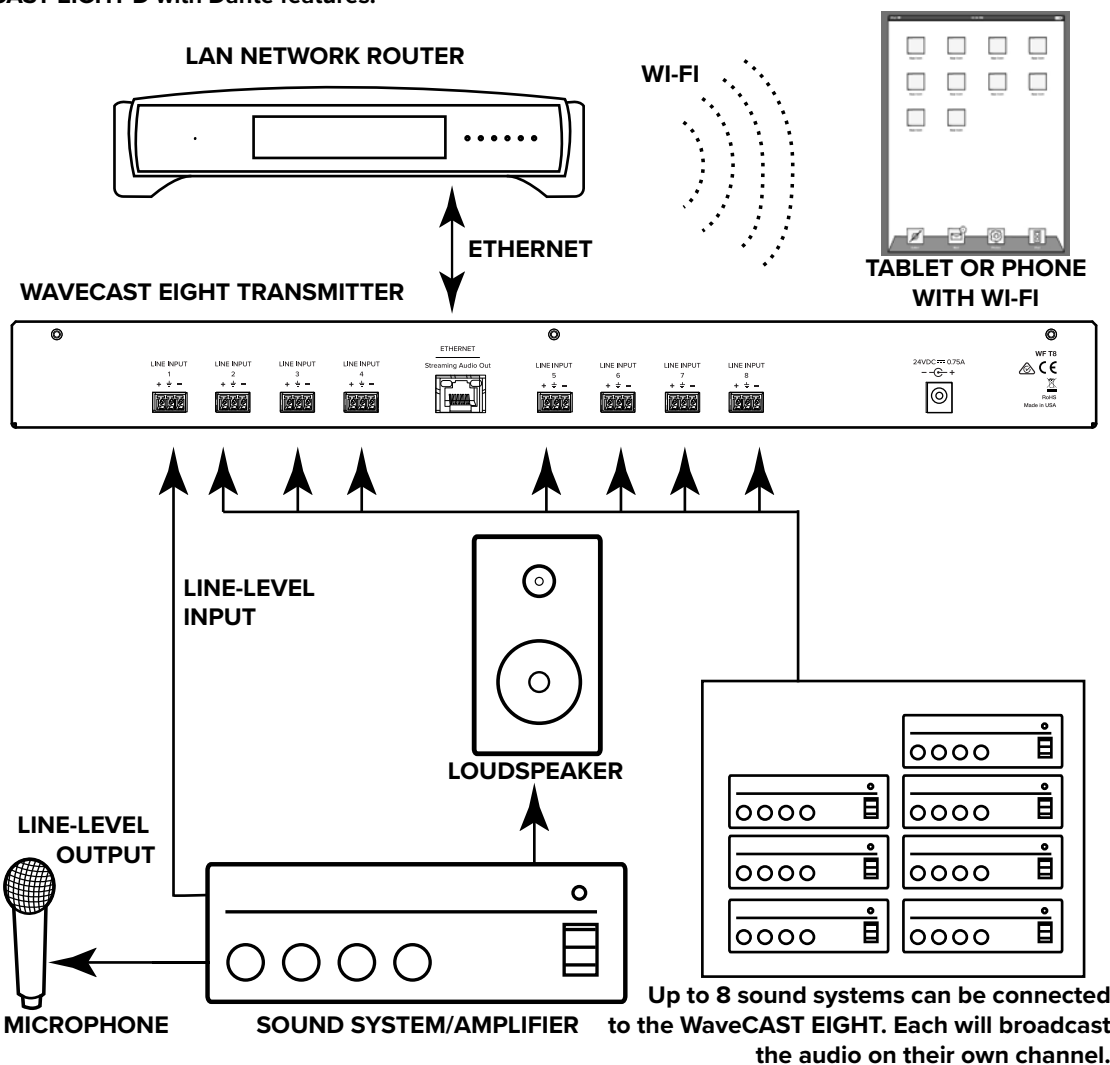

## Quick Setup Instructions

1. Position the WaveCAST EIGHT transmitter near the sound system or mixer from which it will receive audio. We do not recommend wall or ceiling mounting, or putting the device on a cart.
2. Connect the power supply to the Power Supply connector located on the back of the WaveCAST EIGHT. Press the power button on the front of the WaveCAST EIGHT. The power button should light up. If not, go back and check the power connections.
3. Push the power button to turn the unit off.
4. Connect the audio source(s) to the Phoenix-style connectors on the rear of the WaveCAST EIGHT. Each connector will be its own channel.
5. Connect a CAT 5e Ethernet cable from your local area network, or Wi-Fi router to the connector on the transmitter labelled Ethernet. This network will be used to broadcast the audio.
6. Push the power button to turn the unit on.
7. Once the transmitter detects an active network is present, the WaveCAST EIGHT's IP address will be displayed at the top of the main screen
8. Open a web browser on a computer or mobile device that is also connected to the same local network as the WaveCAST EIGHT. In the address bar of the browser, type in the IP address that is shown on the front of the transmitter's main info screen, and push the enter key on the keyboard. (Note: it is not necessary to type "http://" or "www." preceding the IP address, just the characters following "IP:", including the periods)
9. The browser will open the transmitter's web page, displaying a Login button. Click the log-in button and enter the user name "admin" and the default password "admin".
10. The web browser will now show the transmitter's Main Settings tab, which shows the current WaveCAST EIGHT status info. The tabs at the top navigate to different pages that allow adjustment of the settings. The channel to adjust can be selected from the drop down menu at the top right.
11. Adjust any of the server settings, such as the server name, if desired.

*For each channel:*

1. If the channel should be disabled, go to the options page. Uncheck the 'channel enabled' box and click submit. Channels are enabled by default, and will show up on the WaveCAST App. Disabled channels will not show on the app.
2. On the main settings page, adjust the audio gain, unbalanced or balanced audio source, and the audio preset for each channel that will be used. Click submit when finished.
3. Adjust any other channel specific settings as needed.
4. Use a personal device with the WaveCAST App installed to listen to the audio and test that device is working and sounds correct.

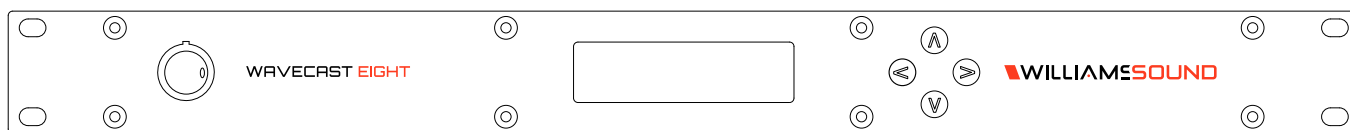

**Front Panel**

## Wi-Fi Network Required

The WaveCAST EIGHT connects to the installation location's Wi-Fi Network. It does not provide a network on its own. The Wi-Fi network will need to be installed and established before the WaveCAST EIGHT can be used.

## Router and Network Equipment Selection

The WaveCAST EIGHT does not come with its own router or networking equipment. It is intended to be set up on an already existing Wi-Fi network; however, upgrades to your network equipment may be necessary depending on the performance desired from the WaveCAST EIGHT. For instance, a higher-end, more powerful router will allow more users to connect to your audio stream than using a cheaper, less powerful router.

The Wi-Fi network will need to be accessible to the users who will be listening to the audio. A public or Guest Wi-Fi network will usually be ideal for ease of accessibility. If the user's devices cannot connect to the network due to security settings, they will not be able to hear the audio.

The WaveCAST EIGHT system will put a demand on the network. If the network cannot handle the demand, whether because it is being used for other networking needs or because the networking hardware is not strong enough, the WaveCAST EIGHT will be unable to reach its maximum audience.

When streaming to a small or medium sized audience, a basic networking configuration may suffice. When streaming music using multiple channels (such as having several WaveCAST EIGHT units on your network), a powerful router and network configuration is more likely to be required.

The **WaveCAST Networking Guide** is available on the Williams AV website for additional networking tips, and applies to all Williams AV Wi-Fi assistive listening products.

## Network and Power Connections

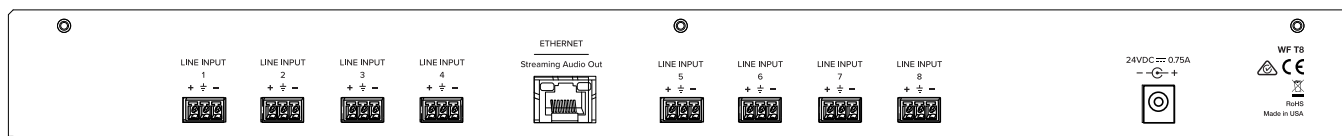

Back Panel

### Power Supply Connection

Connect the power supply to the Power Supply Jack located on the rear of the WaveCAST EIGHT server.

### Network Connection

The **Ethernet** port must be used to connect the WaveCAST EIGHT to local network. A network connection is required to use any features of the WaveCAST EIGHT.

An Ethernet connection will not allow the Wi-Fi broadcast features to work; a Wi-Fi connection must be available on the network.

Once a connection has been established, an IP address will automatically be assigned to the WaveCAST EIGHT (see the front panel section's "Main Menu" on page 14 for help finding the IP Address). Device settings can then be set via the web interface, including changing any network settings.

**NOTE: Most settings need to be set BEFORE connecting audio sources.**

## System Settings

Most settings are adjusted via the web interface by using a computer (see "Web Control Interface" on page 9). A handful of settings can be adjusted via the front panel display (see "Front Panel Interface" on page 14).

## Network Configuration

Network Settings can only be edited from the web interface. An IP address will be automatically assigned to the WaveCAST EIGHT once an Ethernet cable has been connected to the device and network connection found. Additional configuration would need to be made through the web interface.

### Adjusting Network Settings

The Network Settings screen where the IP Address Mode (Static or DHCP), the IP Address, and Subnet Mask are set via the web interface. See "Server Settings Page" on page 12 for details on how to use the web interface.

**IP Address Mode** Static or DHCP

**IP Address** If the IP Address Mode is set to Static, this is where the IP Address is manually entered

**Subnet Mask** If the IP Address Mode is set to Static, this is where the Subnet Mask is manually entered

**Gateway** If the IP Address Mode is set to Static, this is where the gateway is manually entered

**Multicast Address** If needed, the multicast cast address can be enabled and either manually set. If not manually set, a preset fixed address will be assigned by the WaveCAST EIGHT. This setting is under the Options menu and is set per channel.

DHCP IP Addresses are automatically created, and are usually preferred to a manual static IP address.

To set up a static IP Address:

1. Determine an appropriate static IP address for the WaveCAST EIGHT.
  - a. If someone set up your network, they may be able to help you determine an appropriate IP address (i.e. network system administrator).
  - b. There should be no other device having this same address on the network.
  - c. This will be an address on the same subnet as the router.

For example, if the router's address is 192.168.1.100, the first three sets of numbers will be the same (i.e. 192.168.1), and the last number will be the number you determine for the WaveCAST EIGHT (i.e. .100). You can choose another number instead of .100).  
When you determine this address, remember or write it down. You will need it for a later step.
2. Set the Static IP Address for the WaveCAST EIGHT via the web interface of the WaveCAST EIGHT (see "Server Settings Page" on page 12).
  - a. Enter the IP Address you determined earlier. (When entering/saving the new address, the WaveCAST EIGHT will automatically change its IP Address Mode to STATIC)
  - b. Network settings in the WaveCAST EIGHT take place immediately after saving and rebooting.

## Audio Settings

The Audio Settings provide the ability to change the audio characteristics for different listening applications.

### Audio Input Source

The Audio Input Source menu has three possible selections to choose from: Unbalanced Audio, Balanced Audio and a 400 Hz Test Tone.

### Audio Input Gain

The Audio Input Gain adjusts the audio output level from the WaveCAST EIGHT. Changes to the input level will affect the level indicated by the front panel LED's when audio is present. The gain can be adjusted from -96dB to +24dB.

### Audio Presets

The Audio Presets allow the user to quickly and easily configure the WaveCAST EIGHT for common applications. In some cases, the Audio Presets may be the only setup needed for properly configuring the WaveCAST EIGHT server.

There are three pre-configured to choose from: **Hearing Assist, Music, and Voice**. When one of these selections is made, the performance of the WaveCAST EIGHT is immediately optimized for the needs of that application (an adjustment is automatically made to the Low-pass Filter, High-pass Filter, and Compression).

By default, the WaveCAST EIGHT is shipped in the **Music** mode.

For music, concerts, and other applications where the highest audio quality is desirable, **Music** is the recommended mode of operation.

For hearing assistance applications, or applications where the message is critical for listening, **Hearing Assist** is the recommended mode of operation.

For speaking and other voice applications, **Voice** is the preferred mode of operation.

A **Custom** preset is also available for configuring channel-specific audio settings.



## Server Description

The Server Description field allows the user to easily identify the transmitter. This typically comes into play when multiple transmitters need to be distinguished from one another. The description appears on the front main info screen, and also on the web page. In a rack, all the user has to do is activate the main info screen with a touch of any button on the front, and the description is displayed as one of the fields on the main info screen.

The description can only be edited from the web interface.

## Channel Description

The Channel Description allows the listeners to easily identify the channel. The description appears on the channel information screen, on the web page, and in the WaveCAST App. The channel description can only be edited from the web interface.

## Restore Defaults

The Restore Defaults action will restore the transmitter to its original factory settings. Restoring defaults from the front panel of the WaveCAST EIGHT will reset all settings.

On the front panel menu, it is hidden on the main screen (see "Restoring Defaults" on page 15).

Restoring defaults from the web page will reset all settings except Network connectivity settings (IP Address, Subnet Mask, IP Address Mode, and Web Password). This maintains connectivity between the Web Page and the WaveCAST EIGHT, after the WaveCAST EIGHT reboots.

In the web interface, this feature is under the Admin menu.

# Web Control Interface

The WaveCAST EIGHT provides a web interface to manage the device settings. These web pages can be accessed over either a hardwired or wireless network connection with most modern internet browsers.

Changes take effect when applied or saved. Any updates made through the front panel will show up on the web interface once the current page has been navigated away from, either by refreshing the page or going to a new page.

1. Open the web browser of your choice.
2. In the address bar of the browser, type in the IP address of the WaveCAST EIGHT and hit Enter.
3. You should see the Login Page of the WaveCAST EIGHT.
  - If you only see a page asking for a firmware update, your device may have been corrupted. See "Website problems" on page 19.

## Login Page

The default User name is "admin" and the default password is "admin". The user name and the password can (and should) be changed on the website's Admin page.

Check with your system administrator for the most recent login credentials.

Copyright © 2019 Williams AV, LLC | About | WaveCAST Webpage

## Changing Channels

With the exception of some server-wide settings, each webpage is only adjusting the settings for a single channel. To switch channels, use the drop down menu near the navigation bar at the top of the screen. Switching channels will cause the device to reload with the data for the selected channel.

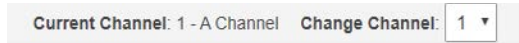

## Main Settings Page

The Main Settings page displays all current audio settings, as well as corresponding WaveCAST EIGHT web-based controls. It is the first page to appear when logging into the website.

An audio monitor is visible at the top of the page. It is for informational purposes only, and does not set any settings.

**Note: Network speed can affect the audio monitor updating and web page performance.**

The transmitter information displays which device is being edited. If needed, the description can be adjusted on the Options page.

Audio Input Gain adjusts the audio volume. A slider is used to adjust the gain.

The audio input source selects the type of audio source that is connected to the selected channel.

Audio Presets adjust the sound to specific settings to improve the audio quality depending on if you are broadcasting audio that is primarily voice, music, or for an audience requiring hearing assistance. The audio settings can also be manually adjusted in the custom presets section.

See "Audio Settings" on page 8 for more details on adjusting any of these settings.

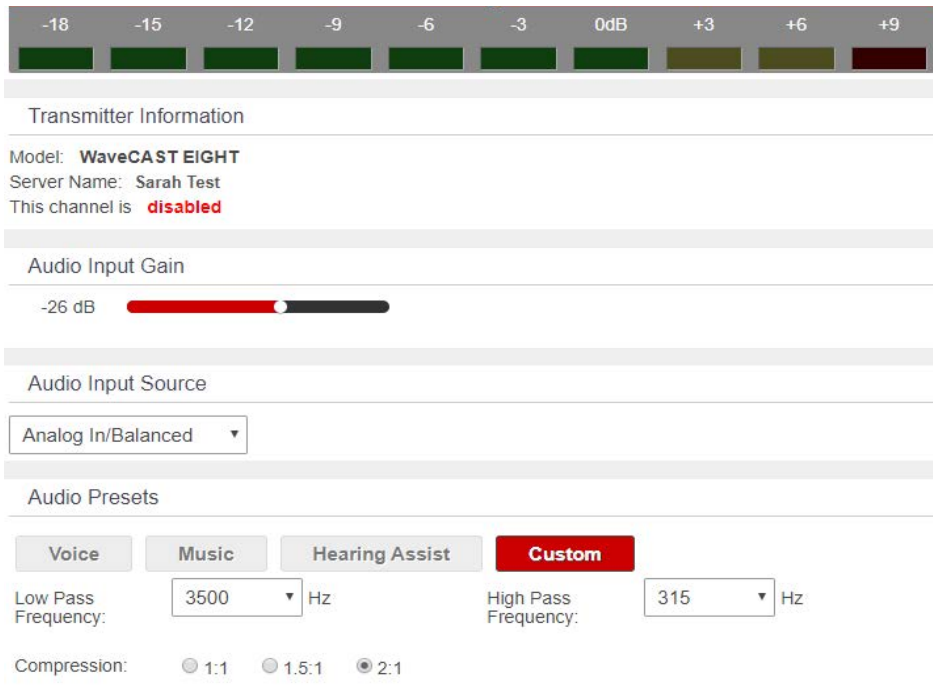

## Options Page

The Options page displays user preferences that can be tailored to each WaveCAST EIGHT channel.

The description sets the name of the channel, which may be used to uniquely identify the device without referring to the IP address.

The channel can be disabled if it will not be used for audio. Disabling the channel will keep the channel from displaying in the WaveCAST App. Channels that are enabled will appear in the app, even when not in use.

Secure Mode can be enabled or disabled, and a 6-digit PIN number can be assigned. If enabled, users will need to use this PIN to log on to the audio stream. Users attempting to listen to the stream without the PIN will be unable to do so.

A multicast address can be automatically assigned. If a specific multicast address is required, the device administrator can enter the desired multicast address. Editing the multicast address will require a reboot of the device.

### Channel Identification

**Channel Name** *Reserved special characters cannot be used.*

### Channel Status

Uncheck this box to disable this channel.

 Channel Enabled

### Advanced Channel Options

**Secure Mode**

Enabled  Disabled **6-digit PIN:**

**Submit**

### Multicast Address

Multicast addresses are typically automatically assigned, but a custom address may also be used.  
**Saving the Multicast address will force a reboot of the WaveCAST EIGHT.**

Declare Custom Address

**Submit**

## Server Settings Page

The Server Settings page affects settings specific to the server as a whole. The page displays network connectivity settings, as well as the server name and screen lock. Typically these are not needed after initial installation.

The screen lock will prevent the front panel on the device from being used, forcing all changes and information to be seen via the web interface. This can also be enabled and disabled from the physical device.

Changing a static IP address or subnet will not instantly take place. The changed IP address or subnet will only take effect once the device is rebooted. This can be done manually or from the Admin menu.

**Note: If the IP address or subnet of the device was changed and the device is being rebooted, the website may not be available at the same URL location. Take note of the network information before rebooting the device.**

TTL can be modified if there is a need. The recommended setting for the least latency is 1, but it can be set up to 31. This setting should not be adjusted without proper consideration for your system setup.

Additional networking information is described in "Adjusting Network Settings" on page 8.

*These settings affect the entire server, not the channel.*

Server Description

Server Channel Number: CH 1 of 1 *Reserved special characters cannot be used.*

Sarah Test

Screen Lock

Locked

Server Network Settings

**Changing these settings will reboot the device.**

DHCP  Static

**Static IP**

192 168 0 0

**Subnet Mask**

255 0 0 0

**Gateway**

223 221 222 220

**MAC Address:** AB-CD-EF-GH

**TTL**

1

A TTL of 1 is recommended for the least latency. The maximum value is 31.

## Upload Image

An image can be uploaded that will display for any users listening using the WaveCAST EIGHT app. This image can be used to easily distinguish the content of your audio broadcast. The image must be under 128kB and be in PNG or JPG format.

The image can be replaced at any time. To completely remove the image, the device must be reset via the front panel menu.

### Channel Image Upload

This image will be displayed to viewers of this channel on the WaveCAST App, which works with the Wi-Fi features of the FM + It can be used to show a logo, a language for interpretation, or any creative icon. *File size limited to 128kB and must be PNG or JPG format*

No file chosen

## Administration Page

The Admin page displays administrative controls that can be used for remote site troubleshooting purposes.

The login username and password for the website can be set from this screen. If the username or password is ever forgotten, it can be restored to its default value by restoring defaults via the front panel menu.

Limited Restore Defaults on the web interface will reset the devices settings that will not affect the website connectivity. Using the limited restore defaults from the web interface will **not** reset the username or password. For a full reset, the reset will need to be performed via the front panel of the device. See "Restoring Defaults" on page 15 for more information.

Firmware updates are performed from the Admin page. At the bottom of the page, upload the firmware file (provided by Williams AV) and hit the update button. Your system will begin the update process from there, which will include a reboot.

Updating or rebooting the device and make the website temporarily unavailable. While the device is restoring, a message warning you to not power off the device will display on the OLED screen.

### Change Password

User Name	<input style="width: 80%;" type="text"/>
Password	<input style="width: 80%;" type="password"/>
Password Verify	<input style="width: 80%;" type="password"/>

### Additional Functions

Reboot

Limited Restore Defaults

Download Error Log

### System Update

Updates can be downloaded off our our company website. [Click here to check for the latest update](#)

**Installed Firmware Version:**  
Main CPU: 1.0.10  
Audio CPU: 1.0.8  
**Website Version:** 1.0.6

---

No file chosen

## Manual Controls and Features

---

### Power Button

The toggle switch turns the transmitter on or off. The desktop power supply provides power to the unit at all times.

### OLED Display

This shows current status of channels and of the WaveCAST EIGHT. Each time the power of the unit is turned on, the OLED Display shows a Williams AV start-up screen and a list of system version numbers. After seven seconds, the default Main Info Screen screen will be displayed.

**NOTE: If the transmitter's internal tests fail, the transmitter will attempt to auto-recover by rebooting itself.**

### Audio Input Level Indicator

The bar graph indicator shows audio level in 3dB steps at the output of the audio level processing circuit. The indicator is peak responding and is calibrated so that optimum level is reached when the VU meter only fully lit (+9dB) occasionally and typically hovers around 2/3rds lit (0dB). Adjust the audio levels from the web interface (see the web interface section's "Audio Settings" on page 8) or from the front panel (see the front panel section's "Main Menu" on page 14).

### Input Overload Indication

The OLED Display shows an exclamation mark (!) above each channel's VU meter as an overload warning each time the audio signal exceeds the capacity of the input circuit. Either the source of the audio coming in to the WaveCAST EIGHT needs to be adjusted to correct this or the Audio Input Gain needs to be adjusted.

### Multiple WaveCAST EIGHT Units

Up to 4 WaveCAST systems (including WaveCAST, WaveCAST EIGHT, FM+ and more) can be used on the same Wi-Fi network. Multiple devices will work better on more powerful networks and routers. The number of servers on the network is visible on the front panel of the WaveCAST EIGHT. The number assigned to a specific server is also visible.

### Main Info Screen

On the main screen, 8 VU meter bars are displayed. Each VU meter represents the audio on one channel. Channels that are disabled will be displayed in darker grey than channels that are enabled. Channels with no active audio will have an empty VU meter.

### Navigating the Front Panel

The arrow buttons (up, down, left and right) on the front panel of the WaveCAST EIGHT are used to navigate the menu. See "Web Control Interface" on page 9 for how to use the arrows on each screen.

### Screen Time Out

If no buttons are pressed on the WaveCAST EIGHT for two minutes, a screen saver will start. If there is no activity while the screen saver is playing for three minutes, the display will shut off.

## Front Panel Interface

---

The front panel can be used to view and adjust certain settings. More settings can be adjusted from the Web Control Interface (see "Web Control Interface" on page 9).

### Main Menu



The main screen of the front panel displays the name of the server, the number of WaveCAST EIGHT servers on the network, the IP address, and a VU meter for each channel.

Use the arrow buttons to highlight menu options. Left and right buttons navigate between fields, while the up and down buttons adjust the field's value.



Some settings appear as you navigate the menu, and may not be visible when the menu is not being navigated.

For example, channel 1's VU meter is highlighted. Selecting this via the left or right arrow buttons will display the gain for channel 1.



When a channel's audio is overloaded, an exclamation point will appear over that channel's VU meter. Adjust the audio for that channel to fix the issue. If no network connection is available, the VU meters may not function, even when audio is playing.

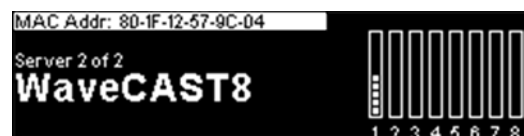

Selecting the IP Address and pressing the up or down arrows will toggle between displaying the IP Address and displaying the MAC Address.

### Restoring Defaults



Restore Factory Defaults is a hidden option underneath the device name. Selecting this option will reset the device to its factory settings, including network and login settings for the Web Control Interface. Two confirmation prompts will appear before the settings are reset, including one to press down to confirm the restoration.

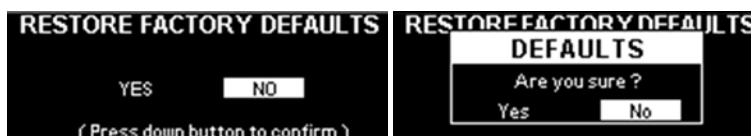

### Locking the Front Panel



To lock or unlock the front panel, hold both the left and right arrows for a few seconds while on the main menu. A pop up will let you know the device is locked. While locked, a pop up message that the device is locked will appear.

### Channel Menu



On the main menu, highlight a channel's VU meter and press and hold the right arrow to view additional information. Some channel settings can be edited. Use the up and down arrows to disable or enable the channel, or adjust the input source.

The preset is visible on this screen, but can only be adjusted from the web interface.

The **multicast address** is visible on this screen, and will display if it is the default address or a user customized address. The multicast address can only be adjusted from the web interface.



Navigate to the bottom of the screen to exit the channel information.

When a channel is disabled, it will show up in a darker grey on the main menu. In this picture, channel 1 is disabled.

## Audio Source Connections

**IMPORTANT: Power down the WaveCAST EIGHT before connecting audio sources. Note that it is often easier to configure the audio source in the menu of the WaveCAST EIGHT before plugging that source in.**

The WaveCAST EIGHT transmitter will accept audio sources via Phoenix style connectors.

Once the WaveCAST EIGHT is connected to a router and audio is present, the audio input level LED's will pulse with the level of the audio.

### Wiring Connections

#### Line Level Source (Phoenix style connectors)

The WaveCAST EIGHT will accept line level balanced or unbalanced audio inputs. Connect your audio source(s) to the appropriate Phoenix style connectors. For each channel, you must select whether the audio source is unbalanced or balanced via the front panel, or from the web interface.

For balanced audio, the + and - Phoenix style terminals are *each tied internally to single differential amplifiers*.

See illustrations for balanced and unbalanced cable configurations.

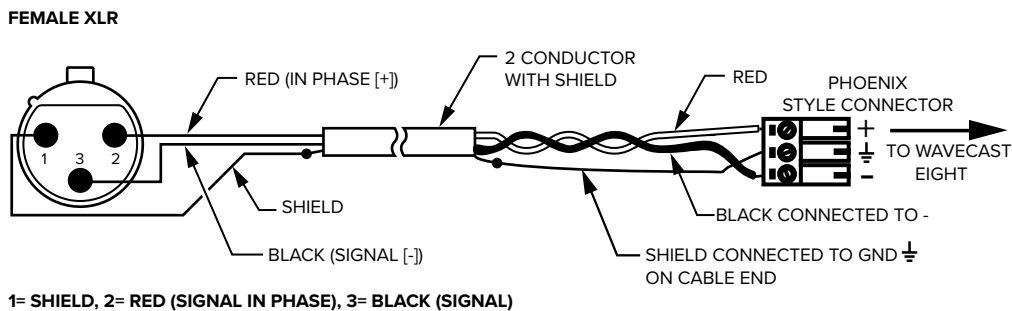

**Figure 5: Balanced line out (XLR) to Controller line input (Phoenix style connector)**

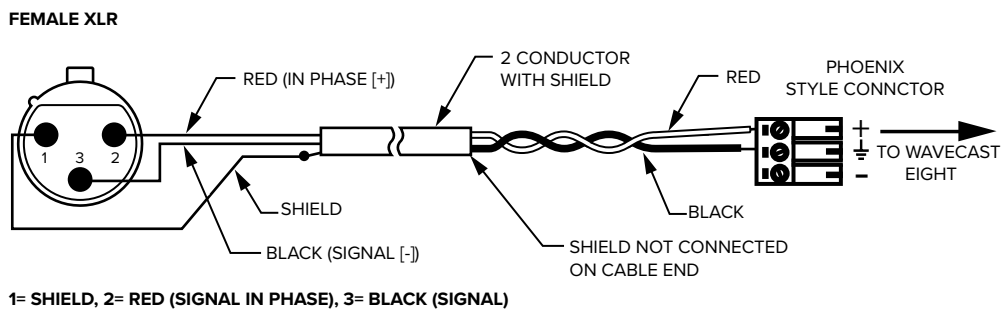

#### Unbalanced line out (XLR) to Controller line input (Phoenix style connector)

#### Summing an unbalanced stereo line-level source to a single mono input

If using a stereo source for an input, the stereo signal will be combined to mono, and heard in mono on the channel.

**Proper Wiring (See yes circle):** The L+ cable can be connected directly to the + connector. The R+ cables should not be used at all.

When summing for stereo to mono only, the resistors, along with the jumper between - and ground, are necessary to allow the left and right signals to be summed before being preamplified by the *single differential (single-ended) amplifier inside the WaveCAST EIGHT*.



**Improper Wiring (See no circle):** If the left and right positive leads from the source were connected to the + and - pins on the Phoenix style connector, and their grounds (shields) were connected to the ground terminal, the result would be the *difference* of the left and right channels. The main part of the audio signal (what is common to both the left and right channels) would be missing, as this is thrown away during *differential amplification*. The difference is *very little*, resulting in a very low input signal. In this case, most of the original audio would not be heard.

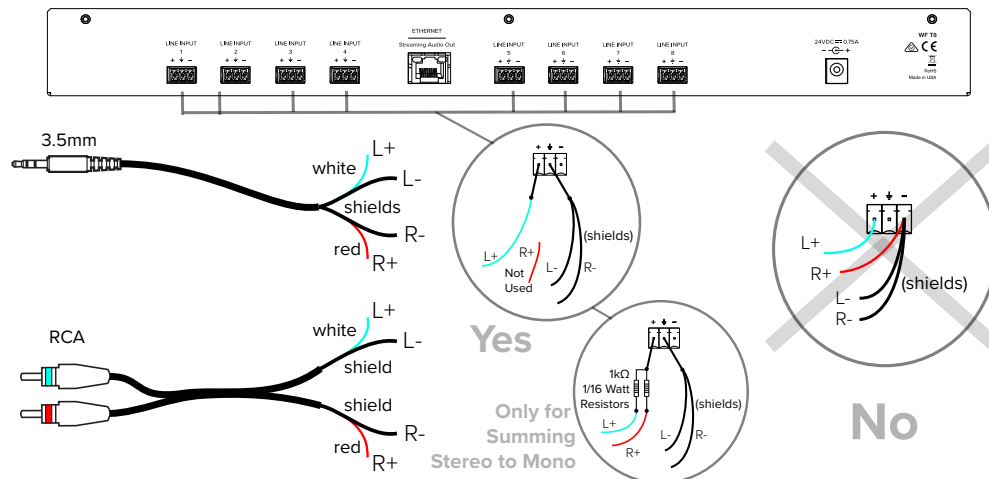

**Improper and Proper Wiring**

## Selecting an Audio Source Appropriate for Hearing Impaired Listeners

The WaveCAST EIGHT transmits audio with excellent fidelity. Therefore, the audio source signal should be of the highest audio quality and not subject to a compressor, limiter, reverberation, or other signal processing equipment. While compressed audio is available through the WaveCAST EIGHT, excessive compression is not helpful to the hearing impaired and can contribute to excessive noise in the audio.

The WaveCAST EIGHT audio source signal is usually connected to a mixer's line output signal which is behind the mixer's parametric equalizers but ahead of any equalization used for house loudspeakers.

## Connecting to other Devices

Each Phoenix-style connector on the back of the device can be connected to an audio source. Each connector will broadcast on its own channel.

## WaveCAST App

---

The WaveCAST app allows listeners to hear the audio on their personal, Wi-Fi connected devices, such as a mobile phone. The WaveCAST App can be downloaded from the Google Play for Android devices or the Apple App Store for iOS devices. The WaveCAST App is compatible with the WaveCAST EIGHT and other Williams Sound Wi-Fi Assitive Listening Systems.

### Connect to Wi-Fi Network

The personal device will need to be connected to the same Wi-Fi network as the WaveCAST EIGHT. Instructions for connecting each device to the Wi-Fi network will differ; check the device manufacturer's instructions for how to set up a connection.

### Connecting the App to the Channel

When the app is opened for the first time, a list of channels will be available. Tap on the channel to hear it's audio.

The channel you are currently connected to will have a blue checkmark next to it.



If a list of channels does not appear, check that the personal device has Wi-Fi enabled. If it does, troubleshoot the network connection of the WaveCAST EIGHT itself.

### Listening via the App

Once connected to the channel, the audio should start playing automatically. The volume of the audio can be adjusted using the slider in the middle of the screen, or the physical buttons on your device.



To mute the audio, tap the speaker icon. Tap it again to unmute the audio.



To switch channels, tap the icon on the bottom of the screen to display the list of channels again.

### Note on Wi-Fi Assist/Smart Network Switching

The network connection the WaveCAST creates is **not** an internet connection. It creates a network connection to the audio stream only.

Some phones expect network connections to provide internet access. When the phone does not reach the internet, it may automatically try to switch to a network connection with an internet connection. Sometimes, the phone determines that the best internet connection is through a mobile data network.

This is not the desired behavior when using the WaveCAST network. The phone will automatically take the user off of the WaveCAST audio streaming network, and onto a unrelated internet network connection. This will prevent the user from hearing the audio, and they may not realize their phone switched networks on them.

Steps for disabling this feature will differ for every phone, but is typically found under the Wi-Fi or Mobile network settings. Look in the manual for your phone for instructions on disabling this feature.

## Troubleshooting

### Ethernet Light Troubleshooting

The LED lights on the Ethernet port can be used to help troubleshoot issues. The following chart explains the light pattern's meaning:

LIGHT	MEANING
Right LED Off	No detected connection to a router
Right LED On	Router Detected
Left LED Off	Audio Transmission Disabled
Left LED Orange	Servers on sub-net syncing
Left LED Green	Servers on sub-net synced; Audio transmitting

### Website problems

#### The full website is unavailable.

- If you are only able to install a firmware update, the website stored on the WaveCAST EIGHT has been corrupted, likely by a power outage. Install the firmware for your current version (or newer) of the WaveCAST EIGHT via the firmware update page to restore the website.
- Check your network settings. The IP address is viewable on the front panel of the device.

#### Lost username or password

- Using the front panel menu, restore defaults. See "Restoring Defaults" on page 15.

#### Website not behaving as expected

- The website will only work with a modern browser. Do not use the website with IE11 or earlier.
- Try switching browsers. Google Chrome is our recommended browser.

### Audio problems

#### Noise or Distortion in the Audio

- Check to see if there is noise in the audio source. To find out, disconnect the audio cable. If the noise disappears your noise problem is in the source. Correct or repair your audio source.
- Check for ground loops or noise on the input signal. If you are still having trouble, call your Authorized Williams AV dealer or representative.
- If audio sounds clipped or is too loud, try to turn down the gain for the channel. These issues may be more noticeable if the VU meter for the channel is displaying the ! overload warning.

#### Noise in audio grows when program is silent

- Check the WaveCAST EIGHT Compression Ratio, which may be inappropriate for the type of program being transmitted. Try setting the Compression Ratio to 1:1 (compression off). See "Audio Settings" on page 8.

### Reception or App difficulties

#### No Reception

- Ensure the listeners have the correct app open are listening on the same channel as the WaveCAST EIGHT.
- Ensure the phone is on the correct Wi-Fi network.

#### Users must turn receiver volume controls way up (near maximum) to get enough volume

- The audio gain control may be set incorrectly on the transmitter. Correct the Audio Gain control setting by adjusting it until the sound level peaks between 0 and 6 dB.
- Some users may not be helped by this system. Severe hearing loss may require using the system with a T-coil and personal hearing aid rather than headphones. Some phones and tablets have the ability to broadcast to a T-coil; research the phone model to see if this is an option.

### **Buzz in other equipment when transmitter is on or off**

- This is likely caused by incorrect audio connections, a ground loop, or defective equipment. To remedy, use proper audio wiring practice to make connections.
- Make certain the transmitter chassis is connected to the equipment cabinet rails. Buzz/hum in system may be experienced when the WaveCAST EIGHT chassis is insufficiently grounded. In this case, install a ground wire to the WaveCAST EIGHT chassis and terminate to a verified ground source.

### **Device is not working over the hardwired Ethernet network**

**Note: If you have a network system administrator, please contact them first before attempting to troubleshoot the network yourself. The following steps are things you can try on a small, non-managed network.**

In this situation you have to check the entire signal path between the control device (laptop or desktop computer) and the WaveCAST EIGHT. You can save some time by pinging the router and WaveCAST EIGHT. Pinging allows you to verify the wiring path without physically having to trace the wires themselves.

1. In order to perform these steps you will need the IP address of the WaveCAST EIGHT and the router. You can find the IP address of the WaveCAST EIGHT via the menu on the front screen of the device.
2. Make sure the WaveCAST EIGHT, Router, and any other devices that may be needed (such as an Ethernet switch) are all connected and powered on. You can save time tracing wiring/hardware paths with these next three steps:
  1. Open a CMD window on the computer. (For example, on Windows 10 computers, in the search box, type "CMD". A black box should come up and the cursor will be blinking.)
  2. Type "ping" followed by a space, followed by the IP address of the WaveCAST EIGHT, and hit Enter. If you see a "reply from...[IP address]" this means the hardwired Ethernet path is OK. If you see "request timed-out", there is most-likely a break in the wiring path between the computer and the WaveCAST EIGHT.
  3. Try pinging the IP address of the router. If you can get a "reply from..." the router, but not the WaveCAST EIGHT, the problem is either in the wiring between the router and WaveCAST EIGHT, or the WaveCAST EIGHT itself could be malfunctioning.
4. Check all of the wiring between the computer and the WaveCAST EIGHT. Make sure every device in the signal path is plugged in, connected, and powered on. Unplug and plug back in firmly all Ethernet cables in the path between the computer and the WaveCAST EIGHT. If you find one that was loose, plug it in and test the device connection again. If none are loose, you could also replace Ethernet cables.

**Note: When checking connections, make sure the WaveCAST EIGHT Ethernet cable is plugged into one of the LAN ports on the router, not the WAN port.**

5. If no loose cables were found, try re-booting in this order
  1. the router
  2. the computer
  3. the WaveCAST EIGHT (turn it off for 10 seconds then turn it back on)Wait at least two full minutes for the WaveCAST EIGHT to re-establish itself on the network. Then try testing the connection again.
4. Once you have verified that you can ping the WaveCAST EIGHT from the computer, open an internet browser on the computer. Type the IP address of the WaveCAST EIGHT into the address bar of the Internet browser.
5. Verify the connection by changing a setting on the WaveCAST EIGHT through the internet browser. If you can change settings and get feedback on the web page (or verify the change on the front display of the WaveCAST EIGHT), you are now connected to the WaveCAST EIGHT.
6. If you can make changes to the WaveCAST EIGHT initially, but then lose that ability (get disconnected), you may have to look at network issues such as IP address conflicts, power issues, or even settings in the router.
7. You can try restoring the WaveCAST EIGHT to factory settings. This will clear out any changes and allow you to start clean.
8. Try directly connecting the WaveCAST EIGHT's Ethernet cable to a PC to verify that the WaveCAST EIGHT and Ethernet cable are operational.
9. If you have tried all of these steps and still can't connect, call Williams AV for additional troubleshooting help. Note that Williams AV cannot help in all cases, as there are many variables within networks.

## Device is not working over Wi-Fi

**Note: If you have a network system administrator, please contact them first before attempting to troubleshoot the network yourself. If you don't have a system administrator, the following steps are things you can try on a small, non-managed network.**

This situation is most often caused by the mobile device losing connection to the router when the Wi-Fi on the mobile device has been turned off (or the Wi-Fi reception is unstable).

1. In order to perform these steps you will need the SSID of the router, the router Wi-Fi connection password, and the IP address of the WaveCAST EIGHT. You can find the IP address of the WaveCAST EIGHT by going into the Menu on the WaveCAST EIGHT itself (using the front buttons and display).
2. Make sure the WaveCAST EIGHT and router are both ON.
3. Make sure the Ethernet cable going to the WaveCAST EIGHT is plugged into one of the LAN ports on the router (not the WAN port).
4. Is the mobile device connected to the router? On the mobile device, go into the Wi-Fi Settings, and make sure Wi-Fi is turned on or enabled. More than one router may show up in the list of possible connections, depending upon how many routers are nearby. If you don't see the router that is connected to the WaveCAST EIGHT in the list, make sure the router is on and broadcasting its SSID.
5. If you see the desired router SSID in the list, connect to it by clicking on it. Usually there is a check mark or some other indication of which router/SSID you are connected to. You may need to enter the Wi-Fi password/passkey to the router to connect to it.
6. Once you have verified that you have connected the mobile device to the router, exit the Wi-Fi settings on the mobile device (without shutting off the Wi-Fi) and open an internet browser. Type the IP address of the WaveCAST EIGHT into the address bar of the Internet browser and hit the Enter key. You should see the WaveCAST EIGHT login web page come up.
7. Verify the connection by changing a setting on the WaveCAST EIGHT through the internet browser. If you can change settings and get feedback on the web page (or verify the change on the front display of the WaveCAST EIGHT), you are now connected to and controlling the WaveCAST EIGHT.
8. Try re-booting in this order
  1. the router
  2. the computer
  3. the WaveCAST EIGHT (turn it off for 10 seconds then turn it back on)

Wait at least two full minutes for the WaveCAST EIGHT to re-establish itself on the network. Then try testing the connection again.

4. If you can make changes to the WaveCAST EIGHT initially, but then lose that ability (get disconnected), you may have to look at deeper network issues such as IP address conflicts, power issues, or even settings in the router.
5. If there is interference, or low Wi-Fi signal on the mobile device, try moving the router to a better location.
6. Some mobile devices have known issues with certain routers. To fix this, you can investigate updating the operating system on the mobile device. Try a different mobile device just to verify that ANY wireless device can connect. If you can get one device connected, but not another, chances are the device that cannot connect has issues. A different brand/model of router may also fix the problem with certain devices not connecting.
7. You can try connecting a computer directly to the WaveCAST EIGHT with a standard Ethernet cable to verify that the Ethernet connection on the WaveCAST EIGHT is working. Once this has been verified you can place the WaveCAST EIGHT back on the network and begin troubleshooting back to the mobile Wi-Fi device.
8. Try connecting to the WaveCAST EIGHT using Wi-Fi on a laptop, rather than a mobile device, to verify that the mobile device is/is not the problem. If you can connect with a laptop, check the Wi-Fi settings on the mobile device and make sure Wi-Fi is turned On.
9. You can try restoring the WaveCAST EIGHT to factory settings. This will clear out any changes and allow you to start clean.
10. If you have tried all of these steps and still can't connect, call Williams AV for additional troubleshooting help. Note that Williams AV cannot help in all cases, as there are many variables within networks.

## Checking Software Versions

### SOFTWARE VERSIONS

Main CPU:	0.0.8
Audio CPUs:	0.0.7
Web Page:	1.0.0

Checking the software version will ensure that your system has the most up-to-date firmware possible. When the device is starting, the various software versions will be visible on the front panel of the device for approximately 3 seconds.

## Specifications

<b>Dimensions</b>	17" W x 7.625" D x 1.72"H (43.18 cm x 19.37 cm x 4.4 cm)
<b>Weight</b>	5.0 lbs (2.27 kg)
<b>Color</b>	Black
<b>Rack Mount</b>	Standard 19" Rack, one EIA rack space high, 1/2 space wide 1–2 units can be mounted in a single rack space with optional RPK 005 (single) or RPK 006 (double) Rack Mount Kits
<b>Power Supply</b>	Desktop Style Transformer (TFP 062); Input: 100-240 VAC, 50/60 Hz. IEC Line Cord; Output: 24 VDC, 750 mA, 18W. 2.5mm ID center positive barrel connector
<b>Power Switch</b>	Rocker; backlit red indicates power on
<b>Temperature Range</b>	Operating: +32° F to +104° F (0° C to 40° C); Storage: -4° F to +158° F (-20° C to 70° C)
<b>Audio Processor Functions</b>	DSP based; Compression: 1:1, 1.5:1 or 2:1; High-pass and Low-pass Filter Frequency control
<b>Frequency Response</b>	31 – 16000 Hz, ±3 dB ("Music" Audio Preset)
<b>Signal-to-Noise Ratio</b>	Greater than or equal to 69 dB (streaming to Iphone)
<b>Total Harmonic Distortion</b>	Less than 0.25% @ 1 kHz
<b>Common Mode Rejection</b>	Greater than 52 dB @ 1 kHz
<b>Audio Inputs</b>	8 Phoenix-style Line Level Analog Audio, Balanced or Unbalanced Line Level
<b>Audio Input Gain Adjust</b>	In menu, adjustable to +6 to -60 dB, in 1dB steps
<b>Ethernet</b>	RJ-45 on back of unit supports CAT 5e cable lengths up to 328 feet (100 meters); 10/100 Base-T IEEE 802.3 compliant, unique MAC address
<b>Approvals</b>	FCC, RoHS3, WEEE, Industry Canada, CE, PSE, RCM, CB Scheme
<b>Warranty</b>	2-year parts and labor

## 2-Year Warranty

Williams Sound, a brand owned by Williams AV, products are engineered, designed, and manufactured under carefully controlled conditions to provide you with many years of reliable service.

Williams AV warrants the WaveCAST EIGHT transmitters against defects in materials and workmanship under normal use and conditions for the 2-years from the product from date of purchase.

This warranty is available to the original end purchaser of the product and can be transferred to subsequent purchasers of the product.

Microphones, earphones, headphones, batteries, chargers, cables, carry cases, and most other accessory products carry a 90-day warranty.

Williams AV has no control over the conditions under which this product is used. Williams AV, therefore, disclaims all warranties not set forth above, both express and implied, with respect to the WaveCAST EIGHT, including but not limited to, any implied warranty of merchantability or fitness of use of such equipment including, without limitation, any warranty that the use of such equipment for any purpose will comply with applicable laws and regulations. Williams AV shall not be liable to any person or entity for any medical expenses or any direct, incidental or consequential damages caused by any use, defect, failure or malfunctioning of the product, whether a claim for such damages is based upon warranty, contract, tort or otherwise, the sole remedy for any defect, failure or malfunction of the products is replacement of the product. No person has any authority to bind Williams AV to any representation or warranty with respect to the WaveCAST EIGHT System. Unauthorized repairs or modifications will void the warranty. This warranty is void if damage occurred because of misuse, or if the product has been repaired or modified by anyone other than a factory authorized service technician. Warranty does not cover normal wear and tear on the product or any other physical damage unless the damage was the result of a manufacturing defect. Williams AV is not liable for consequential damages due to any failure of equipment to perform as intended. Williams AV shall bear no responsibility or obligation with respect to the manner of use of any equipment sold by it.

This warranty does not cover reimbursement for your costs of removing and transporting the product for warranty service evaluation or installation of any replacement product provided under this warranty.

The exclusions and limitations set out above are not intended to, and should not be construed so as to contravene mandatory provisions of applicable law. If any part or term of this Disclaimer of Warranty is held to be illegal, unenforceable, or in conflict with applicable law by a court of competent jurisdiction, the validity of the remaining portions of this Disclaimer of Warranty shall not be affected, and all rights and obligations shall be construed and enforced as if this warranty did not contain the particular part or term held to be invalid. The terms of the warranty are governed by the laws of the State of Minnesota.

Prices and the specifications of the products are subject to change without notice. For Complete Warranty Statement go to: [www.williamsav.com/warranty-statement](http://www.williamsav.com/warranty-statement)

NOTICE: Williams AV products are NOT designed for use in extreme temperature, humidity or chemical environments. The introduction of chemicals such as chlorine, salt water or human sweat into the product will cause damage to the circuitry. Damage due to these causes is NOT covered under the Product Warranty.

If you experience difficulty with your system, call Toll-Free for Customer Assistance

**1-800-843-3544 (U.S.A.)**

**or +1 952 943 2252 (Outside the U.S.A.)**

If it is necessary to return the system for service, your Customer Service Representative will give you a Return Authorization Number (RA) and shipping instructions.

## Regulatory Statements

---

### FCC

#### **FCC Compliance Statement**

This equipment has been tested and found to comply with the limits for a Class B digital device, pursuant to Part 15 of the FCC Rules.

These limits are designed to provide reasonable protection against harmful interference in a residential installation.

This equipment generates, uses and can radiate radio frequency energy and, if not installed and used in accordance with the instructions, may cause harmful interference to radio communications. However, there is no guarantee that interference will not occur in a particular installation. If this equipment does cause harmful interference to radio or television reception, which can be determined by turning the equipment off and on, the user is encouraged to try to correct the interference by one of the following measures:

- Reorient or relocate the receiving antenna.
- Increase the separation between the equipment and receiver.
- Connect the equipment into an outlet on a circuit different from that to which the receiver is connected.
- Consult the dealer or an experienced radio/TV technician for help.

This device complies with Part 15 of the FCC Rules. Operation is subject to the following two conditions:

1. This device may not cause harmful interference, and
2. This device must accept any interference received, including interference that may cause undesired operation.

**Caution:** Any changes or modifications to the equipment not expressly approved by the party responsible for compliance could void your authority to operate the equipment.

#### **SAR Requirement**

This equipment complies with FCC radiation exposure limits set forth for an uncontrolled environment.

This product meets the applicable national or international RF exposure guidance (SAR guideline) when used normally against your head or, when worn or carried, at a distance of 0.5 cm from the body. The SAR guideline includes a considerable safety margin designed to assure the safety of all persons, regardless of age and health.



## IC

### **Industry Canada Statement**

This equipment complies with IC RSS-102 radiation exposure limits set forth for an uncontrolled environment.

Operation is subject to the following two conditions:

1. this device may not cause harmful interference, and
2. this device must accept any interference received, including interference that may cause undesired operation

Cet équipement est conforme aux limites d'exposition de rayonnement d'IC RSS-102 déterminées pour un environnement non contrôlé. Cet

Son utilisation est soumise aux deux conditions suivantes:

1. Cet appareil ne doit pas causer d'interférences et
2. il doit accepter toutes interférences reçues, y compris celles susceptibles d'avoir des effets indésirables sur son fonctionnement.

### **SAR Requirement**

This product meets the applicable national or international RF exposure guidance (SAR guideline) when used normally against your head or, when worn or carried, at a distance of 0.5 cm from the body. The SAR guideline includes a considerable safety margin designed to assure the safety of all persons, regardless of age and health.

Ce produit est conforme aux directives nationales ou internationales sur l'exposition aux fréquences radioélectriques (directives SAR) en vigueur lorsqu'il est utilisé normalement contre la tête ou, porté ou porté, à une distance de 0,5 cm du corps.

La directive SAR inclut une marge de sécurité considérable conçue pour assurer la sécurité de toutes les personnes, indépendamment de leur âge et de leur santé.

**WILLIAMS AV**

[info@williamsav.com](mailto:info@williamsav.com) / [www.williamsav.com](http://www.williamsav.com)

800-843-3544 / INTL: +1-952-943-2252

©2020 Williams AV, LLC MAN 248B