



# Installation Guide & User Manual

---

## **PERSONAL PA Deluxe System 300**

Wireless FM Listening System

Transmitter Model T20  
Receiver Models R7, R7-4

 **Williams Sound**<sup>®</sup>  
Helping People Hear

---





# PERSONAL PA Deluxe System 300

## Installation Guide & User Manual

<b>Contents</b>	<b>Page</b>
<b>Overview</b>	4
<b>Set-Up and Operation</b>	4
<b>T20 Transmitter</b>	
Antenna Connection	
Power Connection	
Audio Connection	
Using a Microphone	
Audio Processor Options	
<b>R7 / R7-4 Receivers</b>	
Using R7, R7-4 Receivers	
Additional Receiver Instructions	
<b>Controls and Features</b>	5
<b>Battery Information</b>	10
<b>Suggestions For Receiver Management</b>	11
<b>Using a Remote Antenna</b>	11
<b>Troubleshooting Guide</b>	12
<b>Radio Interference / Tuning Instructions</b>	14
<b>Warranty</b>	14
<b>System Specifications</b>	15

## Overview

Thank you for purchasing the Personal PA Deluxe System 300 from Williams Sound Corporation.

The PPA 300 is a Wide-band FM Listening System which operates in the 72–76 MHz frequency band. Designed for hearing assistance in places of public access, the PPA 300 is for those who need help overcoming background noise, reverberation, or distance from the sound source. It's easily integrated with your existing sound system or can be used with a microphone as a stand-alone system.

Your PPA 300 has two principal parts: the T20 Transmitter and the R7 or R7-4 Receivers. Much like a miniature radio station, the transmitter and microphone pick up the sounds you want to hear and broadcast them over an FM radio signal. The receivers pick up the broadcast up to 500 feet away.

To avoid difficulties, read through this manual as you begin to use the system. Then save it for questions that arise as you continue to use your PPA system.

If you have any problems with this Williams Sound product, don't hesitate to call us toll-free at 1-800-843-3544.

## Set-Up & Operation

### T20 Transmitter

**Step 1:** Install the antenna.

The “rubber duck” whip antenna fits into the hole on top of the transmitter and threads onto a mounting stud inside. Guide the antenna onto the stud and turn it clockwise to tighten. Do not use excessive force to tighten the antenna. It only needs to be finger-tight.

If the optional remote antenna (ANT 005) is more appropriate, contact your dealer or Williams Sound Corp. The remote antenna installation is detailed on page 11.

**Step 2:** Connect the Transmitter to Power.

The T20 is supplied with a wall transformer power supply (TFP 016). Plug the power cord into the “Power” connector on the rear panel of the T20. Then plug the transformer into a 120 V, 60 Hz wall outlet. The indicator light on the front panel of the T20 should glow when the power is connected.

**There is no ON/OFF switch. Due to low energy consumption, the T20 is designed to run continuously.**

**Figure 1: Overall System Diagram**

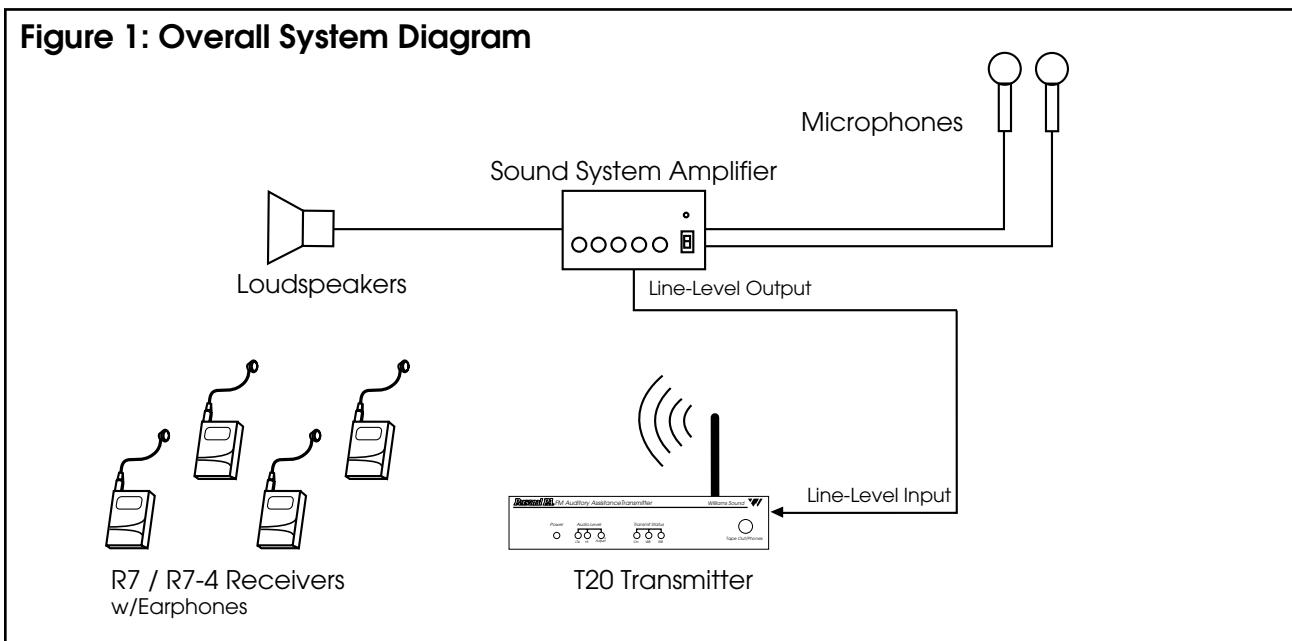

**Figure 2: T20 Transmitter Controls & Features**

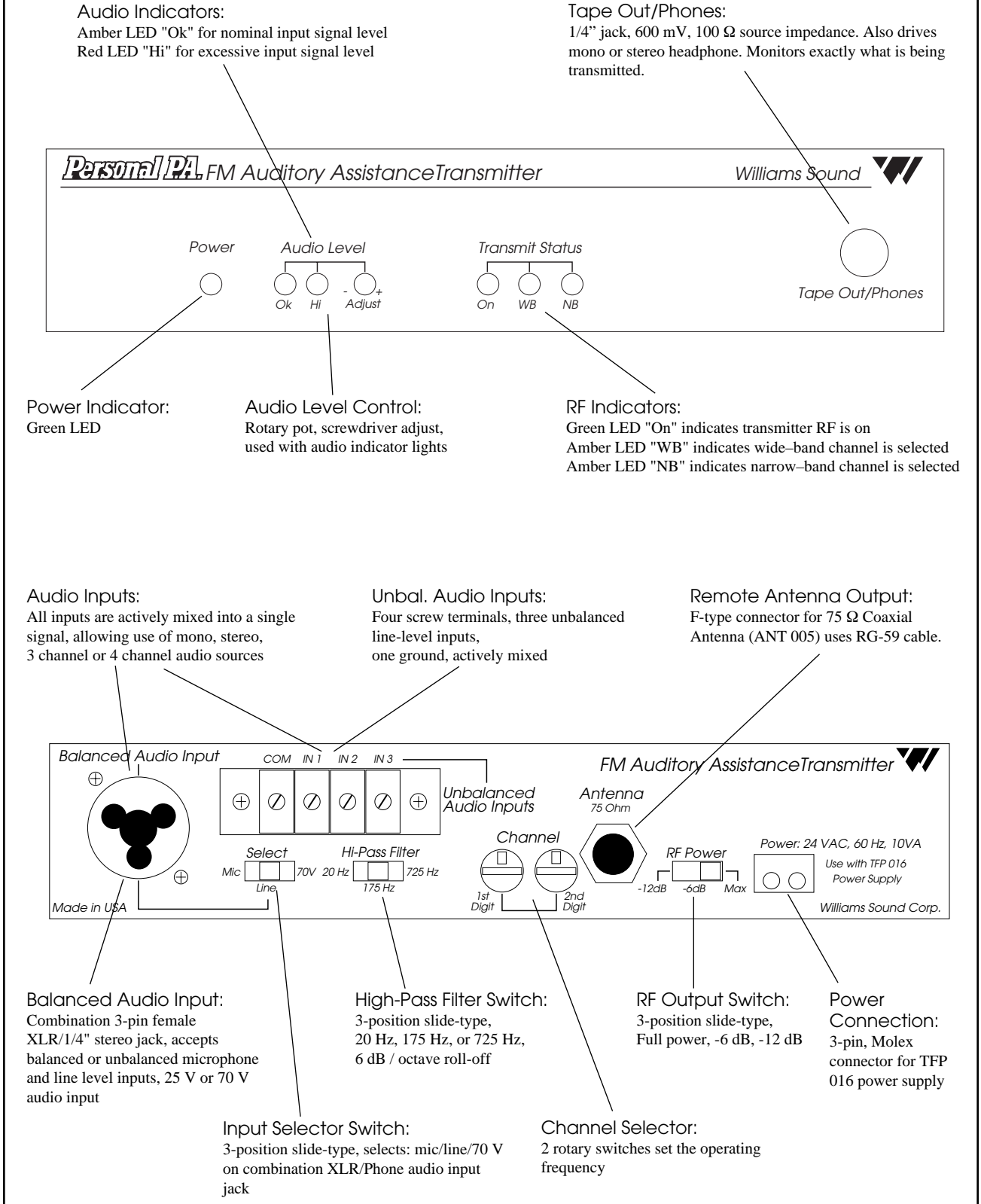

The wall transformer can be plugged into a switched outlet that turns on when the other sound equipment is turned on. If turning the T20 on creates a hum or buzz in the sound system, see the Troubleshooting Guide on page 12.

**Step 3:** Make audio connections.

**Step 3a:** (If you will be using the T20 with an existing sound system)

Refer to the Overall System Diagram, on page 4. The T20 has been designed to accept virtually any type of audio input, with up to four different input signals actively mixed together. The best sources for audio signal from sound system are as follows:

- 1st Choice: TAPE OUT or LINE OUT
- 2nd Choice: BOOSTER or BRIDGING
- 3rd Choice: Speaker Terminal, or Speaker Transformer tap

Input connection options for the T20 transmitter are as follows:

**Balanced Audio Input Concentric Jack:**

1. Accepts balanced and unbalanced XLR or TRS 1/4" Mic-Level or Line-Level Inputs
2. Accepts balanced and unbalanced Mic-Level or Line-Level Inputs
3. Accepts balanced and unbalanced Speaker-Level Inputs (25V, 70V speaker line)

See Figure 4 for connection details.

Use the audio cable and adaptor supplied to connect the T20 "Audio In" jack to an

appropriate audio output jack on the sound system mixer or amplifier. (See Figure 3.)

If your amplifier or mixer does not have RCA-type connectors, you can obtain adaptors from your Authorized Williams Sound Dealer or a local radio parts store. If the TAPE OUT jack is already in use, a Y-Cord can be used to connect the T20 and a second device to the same jack.

**Unbalanced Audio Input Terminals:**

Accepts one to three unbalanced line-level signals, which are actively mixed. The three inputs share a common ground connection.

**Step 3b:** (If you will be using the T20 with a microphone as a stand-alone system)

Any professional low-impedance microphone may be used with the T20. Plug the microphone into the concentric jack ("Balanced Audio Input") on the rear panel of the T20. The T20 supplies positive DC voltage to power condenser microphones per DIN45596. (Standard dynamic microphones may also be used.) Make sure the input selector switch is in the MIC position. Talking into the microphone should cause the audio indicator light to flash on the front panel. If you use both the Microphone input and the Audio Input on the T20, the signals will be mixed.

**Step 4:** Set the Input Selector Switch.

If you are using the combination XLR/phone plug input jack, make sure the selector switch is set in the proper position as shown in Figure 4.

**Figure 3: Using The Audio Cable Supplied With The System**

From Sound System Line Output

To T20 Concentric Jack

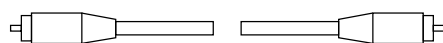

RCA to RCA Cable

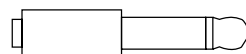

RCA to 1/4" Adapter

**Figure 4: Audio Connection Wiring Detail**

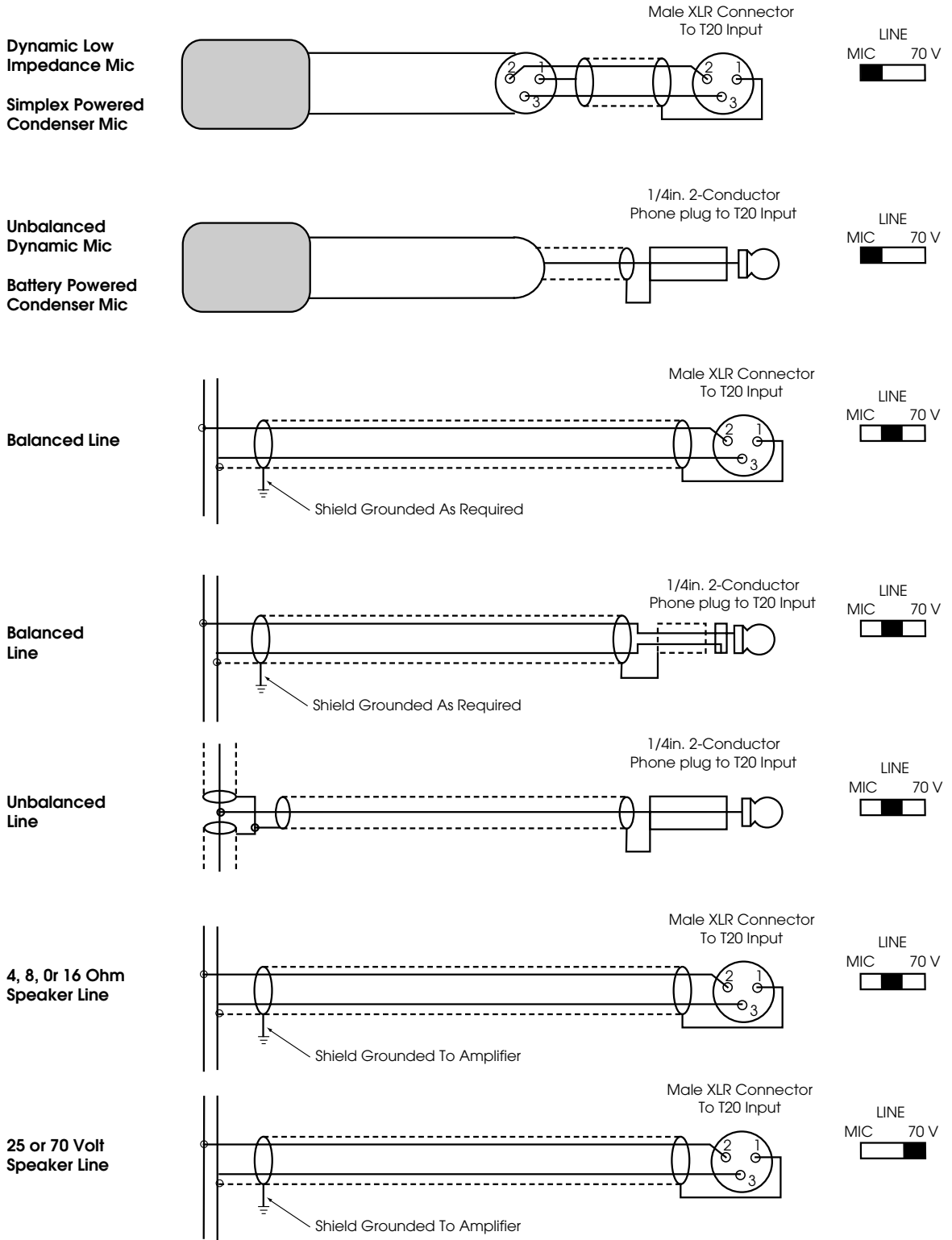

**Figure 5: T20 Audio Processor Performance**

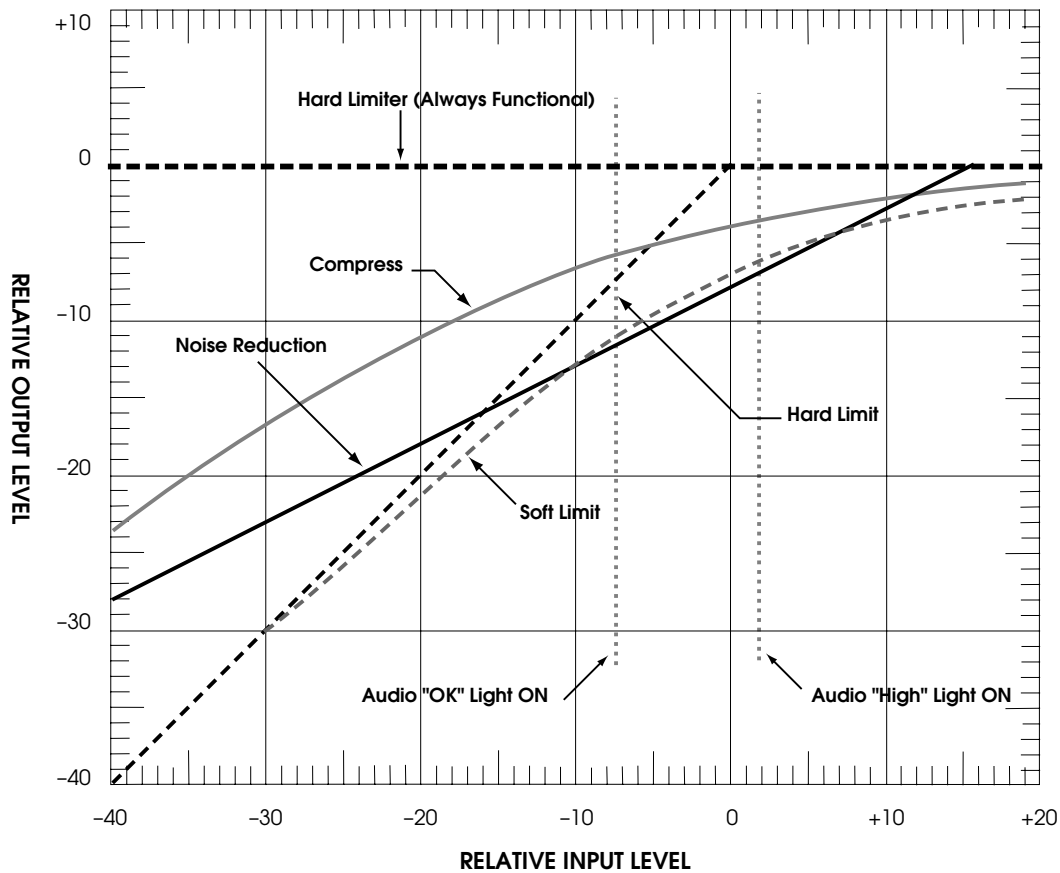

**Step 5:** Set the Hi-Pass Filter Switch.

The High-Pass Filter switch is used to reduce low frequencies. It is normally used in the middle (175 Hz) position to provide high frequency emphasis that improves speech understanding for hard of hearing listeners. If the program content is primarily musical, it can be used in the left (20 Hz) position. The right position (725 Hz) may be used for further low frequency reduction, or it may be used to reduce low frequency system noise due to pick up of ventilation system noise, etc.

**Step 6:** Set the RF Power Switch.

In some situations, the radio signal produced by the transmitter can enter other types of equipment and create a hum or buzzing sound in the sound system. This is due to poor RF protection in the

other equipment, NOT a problem with the transmitter.

The normal switch position is MAX power (right).

If you encounter a hum or buzz in the sound system when the T20 is turned on, move the switch to the -6 dB (middle position). If the buzz diminishes, but persists, move the switch to the -12 dB (left) position. If this does not solve the problem, refer to the Troubleshooting Guide on page 12.

However, if the amount of buzz does not change when the RF power switch is moved from MAX to -12 dB, the buzz is not related to RF interference from the T20.



The system range is decreased when power is reduced, but usually still covers the entire seating area.

**Step 7:** Use a receiver to test the system and set the input level control.

### Audio Processor Options

The audio processor in the T20 is capable of four modes of operation. The effects of these modes are charted in figure 5.

#### Compressor Mode

Compressor mode is used for hearing assistance to limit the dynamic range of the audio signals. Hearing impaired people generally have a reduced tolerance for wide dynamic range. The T20 is shipped in Compressor Mode.

#### Noise Reduction Mode

The T20 can also be configured for for 2:1 compression. This is for use only with a receiver that has a 2:1 expansion circuit for noise reduction. Noise reduction is typically used in narrow-band operation for high quality audio.

#### Soft Limit Mode

The T20 can also operate in a soft limit mode, which allows full dynamic range of audio signals. This mode may be preferred for musical programs, but may provide too much dynamic range for hearing impaired listeners.

#### Hard Limit Mode

Hard Limit Mode is useful if the T20 has been installed with external signal processing.

For assistance in selecting an alternate audio processing mode, contact Williams Sound technical assistance at 1-800-328-6190.

## Receiver Instructions:

### Receiver Models R7, R7-4, R7-6, R16

Receiver Model PPA R7 has a single, wheel-type volume control and an earphone output jack.

**Step 1:** To install the batteries, open the battery compartment using a coin in the slot in the bottom of the receiver. Press the batteries into place, observing proper battery polarity.

**Step 2:** Plug the earphone or headphone into the earphone jack.

**Step 3:** Turn the receiver on by rotating the volume control in the direction of the arrow on top of the case. Turning the knob in the direction of the arrow will increase the volume. Turning the knob against the arrow will decrease the volume. To avoid draining the battery, make sure the receiver is turned off when not in use.

**Step 4:** If you are using the T20 with an existing sound system, make sure the sound system is turned on. Have someone speak into a microphone while you listen with the receiver and earphone. You should be able to hear their voice through the receiver.

If you are using the T20 with a microphone, have someone speak into the microphone while you listen with the receiver and earphone. You should be able to hear their voice through the receiver.

**Step 5:** The T20 Transmitter has a screwdriver-adjusted input level control located on the front panel to compensate for different input signal levels. Adjust the control so the "OK" audio light flashes with the signal. It's alright if the "HI" light comes on occasionally. Reduce the signal level by turning the control counter-clockwise if the "HI" light is on all the time.

If the "OK" light does not come on at all, turn the T20 input level control clockwise to increase the signal. If the input level control is fully clockwise and the "OK"

light still does not come on, you will need to increase the signal level at its source (mixer or P.A. amplifier).

**Note:** The earphone cord is the receiving antenna. Do not bunch up the cord, wrap it around the receiver, or place the receiver in a shirt pocket. The cord should hang as straight as possible.

### Additional Receiver Instructions

#### PPA R7-4, PPA R7-6:

The R7-4 and R7-6 receivers feature a channel selector knob on top of the receiver. Turn the selector knob until you hear the desired program.

#### Model R16:

The R16 Receiver features a microphone input and dual volume controls. The taller knob turns the receiver on and off and controls the FM signal level. The shorter knob controls the microphone signal level. By adjusting the two volume controls, you can hear a mixture of the FM signal and nearby sounds picked up by the microphone. For more information, see the instructions included with the R16.

## Battery Information

In normal use, a heavy-duty 9 Volt battery such as the Eveready 216 will last about 10 hours. Alkaline batteries such as the Eveready 522 will provide about 17 hours of use. If the sound becomes weak or distorted, replace the battery. **The indicator light may still be on, even with a battery that is weak.** Do not leave dead batteries in the receivers.

### Rechargeable Batteries

The receivers can also use a rechargeable battery. We recommend only 7-cell, 8.4 Volt types (BAT 003). (Most batteries available through department and radio stores are 6-cell, 7.2 Volt types. They will not perform satisfactorily with Williams Sound receivers and may be damaged by the Williams Sound BAT 005 Charger) A fully-charged battery (BAT 003) will provide about 5 hours of use per charge. The battery may be recharged without removing it from the receiver.

The BAT 005 Single Charger has a cord that plugs into the receiver "EAR" jack to charge the battery. The CHG 1269A Multiple Charger can charge 12 receivers simultaneously through the receiver "EAR" jacks.

Receivers can be left charging continuously when not in use. The receiver should always be turned OFF while charging. It takes about 14 hours to fully charge the battery.

**!! WARNING !!**  
**DO NOT ATTEMPT TO RECHARGE**  
**DISPOSABLE BATTERIES!**

The batteries may heat up and burst, causing possible injury and damage to the equipment..

Avoid shorting the plus and minus battery terminals together with metal objects. Battery damage and burns can result!

Use only Williams Sound Supplied chargers and batteries!

## Suggestions For Receiver Management

Different types of facilities will use different approaches for receiver management and earphone sanitation. Below are some options that customers have used successfully.

1. Regular users purchase their own receiver and take care of their own batteries and earphone.
2. Some facilities label the receiver and earphone with the names of regular users so each person uses the same receiver and earphone.
3. Ushers issue receivers to people who request them. Earphones are sanitized after use. Foam ear cushions can be replaced or washed with a mild detergent, rinsed thoroughly and air-dried. The EAR 022 Surround Earphone can be sanitized with an alcohol pad.
4. The receivers can be stored in a multiple compartment storage case with a credit card or driver's license left as collateral for the receiver.
5. Regular users purchase their own earphone or headphone and bring them to use with receivers at the facility.

## Using A Remote Antenna

The optional ANT 005 Coaxial Antenna is intended for use with rack-mounted transmitters or in installation areas where a remote antenna is needed for maximum operating distance.

Per FCC Rules, only antennas supplied by Williams Sound may be used with this transmitter.

**Do not cut or alter the antenna cable before reading the instructions below!**

The ANT 005 Coaxial Antenna is a length of coaxial cable with an "F" connector on one end and an 80 in. antenna built onto the other end. The last 80 inches of the antenna make up the active element, which is covered by nylon braid. **The active element should never be altered.** The remainder of the antenna cable is RG-59 coax feedline. The feedline can be shortened if you have the tools to install a new F-connector. If you need a longer feedline, extension cables are available from Williams Sound in 50 foot lengths (WCA 008 50). Never splice coax cables together. Always use proper connectors.

### Installing The Remote Antenna

- Step 1:** Remove the "rubber duckie" antenna from the T20's top panel by turning it COUNTER-CLOCKWISE.
- Step 2:** The ANT 005 Coaxial Antenna connects to the "Antenna" connector on the rear panel of the T20 Transmitter. To use this antenna connector, remove the shrinkwrap with a sharp knife.
- Step 3:** Use a pliers to remove the cap on the connector. Be sure to turn COUNTER-CLOCKWISE to remove the cap.
- Step 4:** Attach the cable, making sure the center wire on the cable enters the hole in the center of the receptacle. The connectors screw together and need only be "finger-tight."

## Remote Antenna Location Guidelines

For maximum signal strength, it is best to select an antenna location somewhere within the listening area. The preferred location is towards the front of the listening area and above the seats. The active element (nylon braid covered portion) should be kept straight, not coiled, and must be vertical.

Radio signals will generally pass through non-metal structures. The antenna can be mounted on a wall, in a corner, or behind a wooden beam. It may also be hung vertically from the ceiling, with a small weight attached to the end to make it hang freely. If you need to run the feedline through a wall, a 1/2 inch hole is necessary to pass the connector through.

**Avoid placing the antenna within four feet of steel beams or near structural steel elements. Metal studs, ductwork, and foil-backed insulation can absorb radio energy, greatly reducing the range of the system. DO NOT put the active element (last 80 inches) inside a metal conduit. The feedline is categorized as Class II wiring. Thus, it may be (but is not required to be) routed through metal conduit, but NOT with microphone cables or AC power wiring.**

Nylon clamps and screws are provided to attach the Coax Antenna to a wall. Locate the clamps every 3–4 feet. DO NOT bend the cable sharply at any point. Allow at least a 3" radius for turns. DO NOT staple the cable in place. Use the cable clamps provided or hang the antenna from the excess nylon braid at the end of the antenna element.

## Troubleshooting Guide

For most efficient troubleshooting, use high quality headphones to monitor what is being transmitted. Plug them into the “Tape Out/Phones” jack on the T20.

### Transmitter “Power” light not on.

1. Make sure the wall transformer is plugged into the transmitter.
2. Make sure the electrical outlet is on.

### No sound through receivers.

1. If some of the receivers work, but others don't, check for bad batteries or earphones on the receivers that aren't working. Check to see that the receiver frequency matches the transmitter frequency. The frequency sticker is on the bottom of the transmitter and inside the back cover of the receiver. If they do not match, see the Tuning Instructions on page 14.
2. If none of the receivers work, check to see if the power is connected to the transmitter and the “Power” light is on. Check to see if the transmitter and receivers are set on the same frequency. Look at the two channel switches on the T20's rear panel, checking the settings against the chart on top of the T20.
4. Check to see if the Transmitter is connected properly to the sound system. See page 6.
5. Turn the screwdriver-adjust input level control located on the T20 front panel clockwise to increase the input signal strength until the audio indicator light flashes.
6. If you are not using an input signal from a sound system, make sure the microphone is plugged into the “Mic” jack on the rear of the T20 transmitter and the input selector switch is in the MIC (left) position.
7. Make sure the antenna is installed and connected properly. See pages 4 or 11.

**Sound is of normal volume. “HI” audio light not continuously on, but sound is distorted.**

1. The source audio might be distorted.
2. Input select switch might be in wrong position. Try other positions.

**Too much noise when talking stops. Normal sound compressed excessively. Red “HI” light lit too frequently.**

1. Turn audio adjust counter-clockwise. Red “HI” light should blink only occasionally. Audio “OK” light should be on when there is normal audio present.
2. Consider changing the audio processor option. The T20 is shipped in Compress Mode. See page 9 for details.

**Sound through the receivers is weak and noisy.**

1. Turn the screwdriver-adjust input level control located on the T20 front panel clockwise to increase the input signal strength until the audio indicator light flashes. The audio fed into the T20 may be noisy or weak. Use a headphone in the “Phones” jack on the front of the T20 to listen to the input signal. If it is weak and noisy from the phones jack, turn up the appropriate mixer control or try a different audio source.
2. Increase the input signal level from the sound system by turning up a mixer control.
3. Make sure a valid wide-band channel is selected and make sure the transmitter and receivers are tuned to the same channel.

**Scratchy noise when receiver volume control is adjusted.**

1. Open the back of the receiver case by opening the battery compartment. Keep lifting on the battery door and the back of the receiver case will open like a book.
2. Remove the screw from the center of the volume control and remove the knob.
3. Lift the clear plastic cover on the control and spray GC SPRA-KLEEN, LPS Contact Cleaner, or equivalent into the control. Replace the knob and rotate the control several times.
4. Replace the screw and close the case.

**Buzzing or humming noise in sound system.**

1. There is nothing wrong with the T20 transmitter. One or more pieces of equipment in the sound system are being disturbed by RF (Radio Frequency) signals produced by the T20. The most likely suspects are your amplifier, mixer, or tape deck. The RF gets into the other equipment primarily through the power cord, speaker wires, or unshielded inputs, all of which can act as antennas.  
Try moving the “RF Power” switch to the -6 dB or -12 dB position. This will reduce the system range somewhat.
2. If remedy one does not solve the problem, we recommend using the optional Coax Antenna (ANT 005), which should be located 15–20 feet away from the other sound equipment. You may add additional RG-59 feedline as needed.
3. If changing to the Coax Antenna doesn’t help, it’s time to dig deeper into the problem. This involves a slight modification to the equipment causing the problem. Unless you have the necessary technical skills, this is best left to a qualified electronics repair technician. Call your Authorized Dealer or Williams Sound Corporation for more information. Ask for the Buzz Paper.

# Radio Interference / Tuning Instructions

The PPA 300 is usually not disturbed by other radio services. However, there are no clear or exclusive channels for ANY radio service. One of the unique features of the PPA System 300 is that the operating frequency can easily be changed to an alternate channel in the field to avoid interference.

The T20 Transmitter provides 10 wide-band and 10 narrow-band standard frequencies for hearing assistance use.

## Transmitter Frequency Change Procedure:

Set the two rotary "Channel" selector switches to match the desired channel listed on the chart on top of the transmitter. (See Figure 6.)

One of the 10 standard wide-band channels must be selected for use with R7 or R7-4 Receivers. The narrow-band channels are available for use with Williams Sound's line of narrow-band receivers, including the R19, and R19-4.

**Figure 6: T20 Channel Selection**

### Wide-Band Channels

1st Digit	2nd Digit	Freq (MHz)	CH
0	0	NA	NA
0	1	72.100	A
0	2	72.300	B
0	3	72.500	C
0	4	72.700	D
0	5	72.900	E
0	6	75.500	F
0	7	75.700	G
0	8	75.900	H
0	9	74.700	I
1	0	75.300	J

### Narrow-Band Channels

1st Digit	2nd Digit	Freq (MHz)	CH
1	1	72.025	11
1	2	72.075	12
1	3	72.100	13
1	4	72.125	14
1	5	72.175	15
1	6	72.225	16
1	7	72.275	17
1	8	72.300	18
1	9	72.325	19
2	0	72.375	20
2	1	72.425	21
2	2	72.475	22
2	3	72.500	23
2	4	72.525	24
2	5	72.575	25
2	6	72.625	26
2	7	72.675	27
2	8	72.700	28
2	9	72.725	29
3	0	72.775	30
3	1	72.825	31
3	2	72.875	32
3	3	72.900	33
3	4	72.925	34
3	5	72.975	35
3	6	74.625	36
3	7	74.675	37
3	8	74.700	38
3	9	74.725	39
4	0	74.775	40
4	1	75.225	41
4	2	75.275	42
4	3	75.300	43
4	4	75.325	44
4	5	75.375	45
4	6	75.425	46
4	7	75.475	47
4	8	75.500	48
4	9	75.525	49
5	0	75.575	50
5	1	75.625	51
5	2	75.675	52
5	3	75.700	53
5	4	75.725	54
5	5	75.775	55
5	6	75.825	56
5	7	75.875	57
5	8	75.900	58
5	9	75.925	59
6	0	75.975	60
61 - 99		NA	NA

Note: NA = Not Available

## Receiver Frequency Change Instructions

Tuning for the R7, R7-4, and R-16 Receivers is determined by a single tuning coil, and is stabilized by phase-locked-loop circuitry. A plastic tuning wrench (PLT 005) is needed to adjust the receiver tuning coil.

- Step 1:** Use the transmitter as a tuning signal source. Have someone speak into the microphone so you have something to listen to.
- Step 2:** Disconnect the antenna from the transmitter. The receiver must be tuned under weak signal conditions.
- Step 3:** Open the back of the receiver to expose the circuit board. Open the receiver battery flap first. The receiver back snaps open like a book.
- Step 4:** Locate the tuning coil. (See Figure 7.) Use the headphone supplied with the receiver to listen for the transmitter signal while you slowly and gently rotate the tuning slug inside the tuning coil with the tuning wrench inside the tuning coil with the tuning wrench. Adjust the tuning coil slowly and carefully. Do not press down on the tuning slug. Adjust for maximum signal.
- Step 5:** Re-tune all the receivers and mark the new frequency inside the case for future reference.

## Warranty

The Williams Sound T20 Transmitter and R7, R7-4, R7-6, and R16 Receivers are warranted against defects in workmanship and materials for FIVE YEARS. Microphones, earphones, cables, carry cases, rechargeable batteries and chargers are warranted against defects in workmanship and materials for NINETY DAYS. This warranty does not extend to intentional or accidental physical damage. This warranty applies only to products returned to Williams Sound for service. To return a product for service, call 1-800-843-3544 and request a Return Authorization (RA) number.

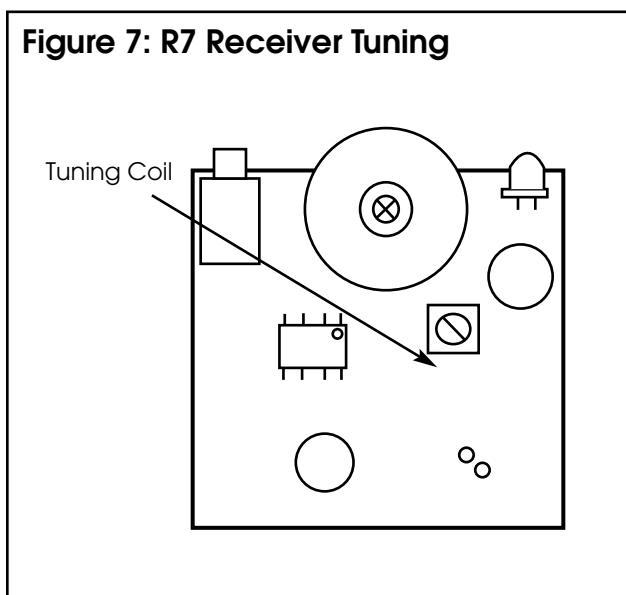

# PERSONAL PA SYSTEM 300 SPECIFICATIONS

## PERSONAL PA Transmitter Model T20

Dimensions, Weight: 8.45" (21.5 cm) W x 8.18" (20.8 cm) D x 1.72" (4.4 cm) H, 3 lbs. (1.5 kg)  
Color: Black epoxy paint with white legends  
Rack Mount: One IEC rack space high, one or two units can be mounted in a single rack space with optional RPK 005 (single) or RPK 006 (double) Rack Mount Kits  
Power: External power supply(TFP 016), 24 VAC, 50 or 60 Hz, 10 VA, 230 mA max. current drain  
FCC ID: CNMT20  
Operating Freqs: 72-76 MHz, 10 wide-band and 10 narrow-band channels,  
Stability:  $\pm .005\%$  stability, 0-50°C  
Deviation:  $\pm 75$  kHz max. for wide-band channels,  $\pm 5$  kHz max for narrow-band channels  
Pre-Emphasis: Wide-band: 75  $\mu$ sec, narrow-band: 300  $\mu$ sec  
RF Field Strength: 8000  $\mu$ V/m at 30 m max., 20 mW typical  
Nominal Range: 300-500 ft. (90-150 m)  
AGC Options: (1)Standard variable slope compressor/limiter (2)Noise Reduction (3)Soft Limit (4)Hard Limit  
Frequency Response: WB: 30 Hz - 15 kHz  $\pm 3$  dB, .25% Max. THD  
NB: 30 Hz - 5 kHz  $\pm 3$  dB, .25% Max. THD  
Signal to Noise Ratio: 60 dB with R7 Receiver

### Front Panel:

Power Indicator: Green LED  
RF Indicators: Green LED "On" indicates transmitter RF is on  
Amber LED "WB" indicates wide-band channel selected  
Amber LED "NB" indicates narrow-band channel selected  
Audio Indicators: Amber LED "Ok" for nominal input signal level  
Red LED "Hi" for excessive input signal level  
Audio Level Control: Rotary pot, screwdriver adjust, used with audio indicator lights

## PERSONAL PA Receiver, Model PPA R7

Dimensions & Weight: 3-5/8" L x 2-3/8" W x 7/8" H (92.1 mm x 60.3 mm x 22.2 mm)  
3.2 oz (90 g) with battery  
Color: Gray  
Battery Type: 9 Volt, Eveready 522 Alkaline or BAT 003 Ni-Cad  
Battery Drain: 14 mA, nominal  
Battery Life: 32 hours with Eveready 522, 6 hours/charge with BAT 003  
FCC ID: CNM R7Y  
Operating Freq.: Pre-Tuned, Adjustable, 72 MHz - 76 MHz \*  
Intermediate Freq.: 70 kHz  
FM Deviation: 30 kHz  
De-Emphasis: 75  $\mu$ s  
AFC Range:  $\pm 300$  kHz

Tape Output: 1/4" jack, 600 mV, 100 $\Omega$  source impedance, also drives mono or stereo headphone

### Rear Panel:

Audio Inputs: All inputs are actively mixed into a single signal, allowing use of mono, stereo, 3 channel, or 4 channel audio sources  
Balanced Audio Input: Combination 3-pin female XLR/1/4" stereo jack, accepts balanced or unbalanced microphone and line level inputs, 25 V or 70 V audio input  
Mic Input Levels: Lo-Z, 100  $\mu$ V min. to 50 mV max. 1 mV nominal, 3 k $\Omega$  input impedance. Supplies simplex power 20 V (DIN45596) for condenser mics  
Line Input Levels: 21 mV min. to 10 V max., 212 mV nominal, 100 K $\Omega$  input impedance  
70 Volt Input Levels: 216 mV min. to 100 V max., 2.16 V nominal, 100 K $\Omega$  input impedance  
Unbal. Audio Inputs: Four screw terminals, three unbalanced line-level inputs, one ground, actively mixed  
Input Selector Switch: 3-position slide-type, selects: mic/line/70 V on combination XLR/Phone audio input jack  
High-Pass Filter Switch: 3-position slide-type, 20 Hz, 175 Hz, or 725 Hz, 6 dB/octave roll-off  
RF Output Switch: 3-position slide-type, Full power, -6 dB, -12 dB  
Antenna Outputs: Thread Mount for "rubber duckie" flexible whip antenna, optional hard-wired 75  $\Omega$  Coaxial Antenna (ANT 005) uses RG-59 cable, 400 ft. (140 m) max. cable length  
Power Connections: 3-pin Molex connector  
Channel Selector: 2 rotary switches set the operating frequency

Sensitivity: 2  $\mu$ V at 12 dB Sinad with squelch defeated  
Squelch: Squelches at 10  $\mu$ V for minimum 50 dB S/N ratio  
Input Overload: 20 mV  
Frequency Response: 100 - 10 kHz,  $\pm 3$  dB  
Signal-to-Noise Ratio: 50 dB at 10  $\mu$ V  
Receive Antenna: Integral with earphone/headphone cord  
Audio Output: 250 mW, max. at 16 Ohms  
Output Connector: 3.5 mm mini phone jack, also serves as a charging jack for rechargeable battery  
Earphone: Earbud-type with foam cushion, 3.5 mm plug, 32  $\Omega$