



MANUAL AND USER GUIDE

FM TOUR GUIDE SYSTEM

Model TGS 300

Transmitter Model PFM T31
Receiver Model TGS R30

MAN 118B

FM TOUR GUIDE SYSTEM, MODEL TGS 100

INSTALLATION GUIDE & USER MANUAL

Contents	Page
System Overview	4
System Components	5
PFM T31 Transmitter	
Microphones	
TGS R30 Receiver	
Headphones & Earphones	
Safety Information	6
Recycling Instructions	7
Operating Instructions	7
PFM T31 Transmitter	
TGS R30 Receiver	
Hints for Using the System	
Battery Information	11
Battery Installation	
Rechargeable & Non-rechargeable Batteries	
Using Optional Battery Chargers	
In Case Of Difficulty	14
Warranty	15
System Specifications	16

SYSTEM OVERVIEW

The FM Tour Guide System is a portable, high-performance, wireless system composed of the PFM T31 Transmitter and TGS R30 Receivers and designed for use in guided tour applications. The system allows one-way transmission of a tour guide's voice to group members using an FM radio signal. Using the system helps group members overcome background noise and distance from the person speaking.

The FM System can be used for large or small tour groups and in noisy or quiet environments.

Your FM Tour Guide System has two principal parts: the transmitter and the receiver. Much like a miniature radio station, the transmitter and microphone pick up the sounds you want to hear and broadcast them over an FM radio signal. The receivers and headphones are used to pick up the broadcast up to 100 meters away.

To avoid difficulties, please read through these instructions as you begin to use the system. Then save them for questions that arise as you continue to use your system.

If you have problems with the FM Tour Guide System, don't hesitate to call Williams Sound at 1-800-843-3544.

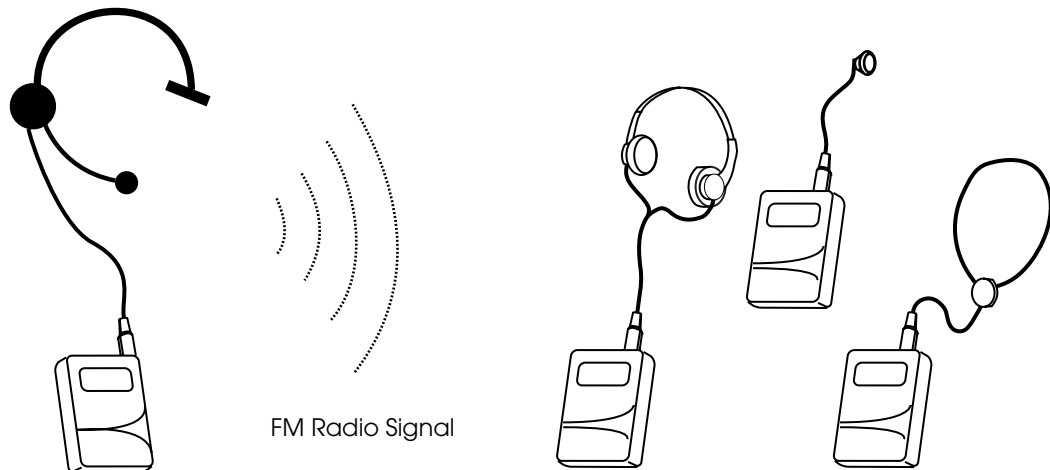

Tour Guide Uses the Body Pack Transmitter With Microphone

Listeners use Personal Receivers with Earphones, Headphones, Or Neckloop

The tour guide wears the body-pack transmitter and headset microphone. The guide's voice is broadcast as an FM radio signal over a distance of up to 100 meters. Listeners use the pocket receiver and headphone to hear the speaker's voice directly, with reduced background noise. A neckloop telecoil coupler allows the system to be used with telecoil (T-Switch) equipped hearing aids, at somewhat reduced range.

SYSTEM COMPONENTS

- ▶ Body Pack Transmitter (PFM T31) with (2) AA batteries (BAT 001)
- ▶ Noise-cancelling headband microphone (MIC 086)
- ▶ (6) Personal FM Receivers (TGS R30) w/batteries (BAT 001) and headphones (HED 021)
- ▶ Belt clip cases (CCS 001)
- ▶ Instruction Manual
- ▶ System carry case (CCS 030 S)

THE PFM T31 TRANSMITTER

The PFM T31 Transmitter is a battery-powered body-pack model used with a microphone to pick up the tour guide's voice. The transmitter produces an FM radio signal to broadcast the tour guide's voice to the receiver units. A simple slide switch on top of the transmitter turns the unit on or off. The PFM T31 operates on two AA non-rechargeable alkaline batteries (BAT 001), or two AA rechargeable NiMH batteries (BAT 026).

MICROPHONES

A noise-cancelling, headband microphone (MIC 086) is the standard microphone. The noise-cancelling microphone helps to reduce background sounds in noisy environments. The microphone plugs into the "MIC" jack on top of the Transmitter. The microphone should be positioned directly in front of the tour guide's mouth to achieve an optimal signal to noise ratio and so that head movement does not affect the loudness of the signal. The microphone cord acts as the transmitting antenna.

Optional Microphones

An optional Hearing Protector Headset Microphone (MIC 036) is also available for extremely high noise environments. It features ear muffs that completely cover both ears and provides 24 dB noise isolation for hearing protection.

An optional Lapel Clip Microphone can be used in quieter environments like museums or galleries. The MIC 090 has an omnidirectional pick-up pattern. The MIC 056 has a directional (or cardioid) pick-up pattern, which will reduce background noise.

A small hand-held microphone (MIC 026) is also available for tour guides who prefer to hold the microphone.

THE TGS R30 RECEIVER

The TGS R30 Receiver is a battery-powered body-pack receiver used with a headphone to hear the signal produced by the transmitter. The receiver is pre-tuned to the transmitter and has a user-adjustable volume control. The headphone plugs into the "EAR" jack on top of the Receiver. The receiver is turned on by rotating the volume control wheel. The TGS R30 Receiver operates on two AA non-rechargeable alkaline batteries (BAT 001), or two AA rechargeable NiMH batteries (BAT 026).

HEADPHONES AND EARPHONES

The HED 021 Lightweight Headphone is the standard headset for the Tour Guide System. It offers excellent sound quality and wearing comfort. The foam earpads may be removed and washed in a mild detergent, rinsed thoroughly, and air dried. Replacement pads (HED 013) are available.

The headphone plugs into the “EAR” jack on top of the Receiver. The headphones are wired with a mono plug. If a stereo headphone is substituted, it will only work on one side of the headphone.

OPTIONAL HEADPHONES AND EARPHONES

The HED 008 is a heavy-duty, hearing-protector headset. The HED 008 earmuffs completely cover the ears and provide 24 dB noise isolation for hearing protection in high noise environments.

The EAR 022 Surround Earphone offers excellent sound quality in a unique style that hangs on the ear. It is easy to keep clean since the earphone does not enter the ear. It is not recommended for high noise environments.

The EAR 013 and EAR 014 are single and dual Mini Earphones. The earbud-style features a foam covering that fits in the outer ear. The foam pads can be removed for cleaning or replacement. Replacement pads (EAR 015-10) are available.

The stylish HED 026 rear-wear headphone offers excellent sound quality; it rests comfortably over the ears and wraps around the back of the head for a less obtrusive, relaxed fit.

EARPHONE / HEADPHONE OPTIONS



HED 008



HED 021



HED 026



EAR 022



EAR 013



EAR 014

SAFETY INFORMATION

HEARING SAFETY



CAUTION!

This product is designed to amplify sounds to a high volume level which could potentially cause hearing damage if used improperly. **To protect your hearing and the hearing of others:**

1. Make sure the volume is turned down before putting on the earphone or headphone before adjusting the volume to a comfortable level.
2. Set the volume level at the minimum setting that you need to hear.
3. If you experience feedback (a squealing or howling sound), reduce the volume setting and move the microphone away from the earphone or headphone.
4. Do not allow children **or other unauthorized persons** to have access to this product.

BATTERY SAFETY AND DISPOSAL



CAUTION!

This product is supplied with disposable Alkaline batteries. Do not attempt to recharge disposable batteries, which may explode, release dangerous chemicals, cause burns, or other serious harm to the user or product.

PACEMAKER SAFETY:



CAUTION!

1. **Before** using this product with a pacemaker or other medical device, consult your physician or the manufacturer of your pacemaker or other medical device.
2. If you have a pacemaker or other medical device, make sure that you are using this product in accordance with safety guidelines established by your physician or the pacemaker manufacturer.

RECYCLING INSTRUCTIONS

BATTERY SAFETY AND DISPOSAL



Help Williams Sound protect the environment! Please take the time to dispose of your equipment properly.

Product Recycling for Customers in the European Union:

Please do NOT dispose of your Williams Sound equipment in the household trash. Please take the equipment to a electronics recycling center; OR return the product to the factory for proper disposal.

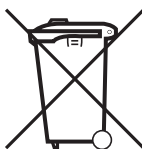

Battery Recycling for Customers in the European Union:

Please do NOT dispose of used batteries in the household trash. Please take the batteries to a retail or community collection point for recycling.

8/18/05

OPERATING INSTRUCTIONS

USING THE PFM T31 TRANSMITTER

Instructions:

Before you begin, make sure you have AA Alkaline batteries installed in the transmitter. See *Battery Information*, page 11.

1. Plug the microphone into the “mic” jack on top of the transmitter.
2. Turn the power on: Place the FM switch to the “On” position.
3. Position the microphone as close to the speaker’s mouth as practical.
4. When you are ready to speak, turn the Mic Mute Switch to the “On” position. When you are done speaking, mute the mic by turning the switch to the “Off” position. This will eliminate any unwanted noise as a result of the transmitter being on.

Note: The microphone cord is also the transmitting antenna. For maximum range, make sure the microphone cord is hanging as straight as possible.

5. Remember to turn the transmitter off when you are done using it: Turn the “FM” switch to the “Off” position.

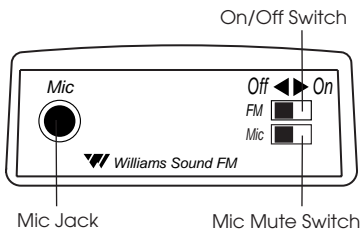

NOTE ON THE TRANSMITTER ANTENNA:

The microphone cord is the transmitting antenna. Do not bunch up the cord, wrap it tightly around your body, or wrap it around the transmitter. For maximum range, the cord should hang as straight as possible. The transmitter can be placed in a pants pocket, or clipped onto a belt or waistband. Make sure the transmitter is turned OFF when not in use.

CHANGING THE PFM T31 FREQUENCY

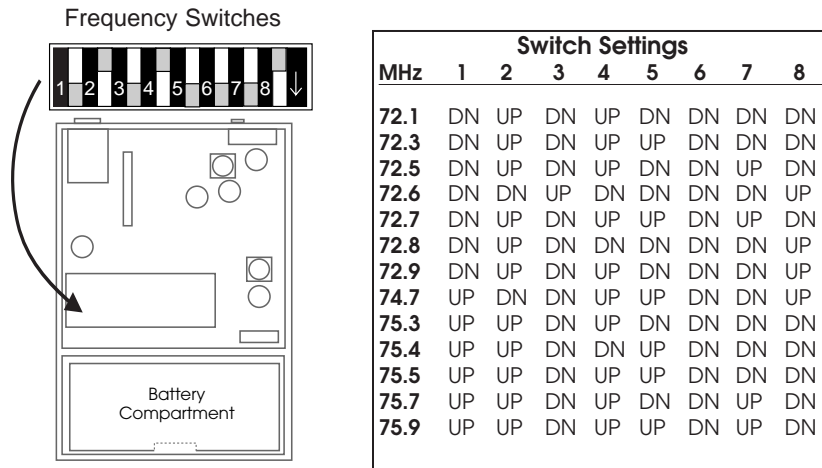

Begin by opening the battery compartment door. Remove the batteries, then open the back panel to expose the circuit board. Referencing the Switch Settings chart (above), adjust the frequency switches on the PFM T31 transmitter accordingly using a small screw driver or paper clip. Reinstall the batteries, then close the back of the transmitter. Plug in the mic, and turn on the transmitter to provide a tuning signal for the receivers. Be sure to change the receiver to the corresponding channel.

USING THE TGS R30 RECEIVER

Note: Rechargeable batteries are shipped in a discharged state and must be charged overnight before using.

1. Make sure there are two charged AA batteries in the Receiver. If batteries are not installed, see *Battery Information*, page 11.
2. Plug the earphone or headphone into the "Ear" jack on top of the Receiver.
3. Place the headphones over your ears.
4. Turn the power on by rotating the volume control thumbwheel on top of the Receiver.
5. Adjust the receiver volume control to a comfortable listening level. You should be able to hear someone speaking into the transmitter microphone.
6. Place the receiver in the belt clip case provided. The receiver can be placed in a pants pocket, or clipped onto a belt, harness, or waistband.

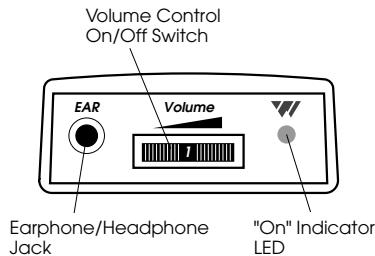

TGS R30 FREQUENCY CHANGE INSTRUCTIONS

Selecting a frequency for the R30, R31, R32 and R7-4 receivers requires an adjustment to the internal tuning coil(s). See figure below for receiver types to locate the coils to be adjusted. A plastic tuning wrench (PLT 005) will be needed to adjust these receiver tuning coils.

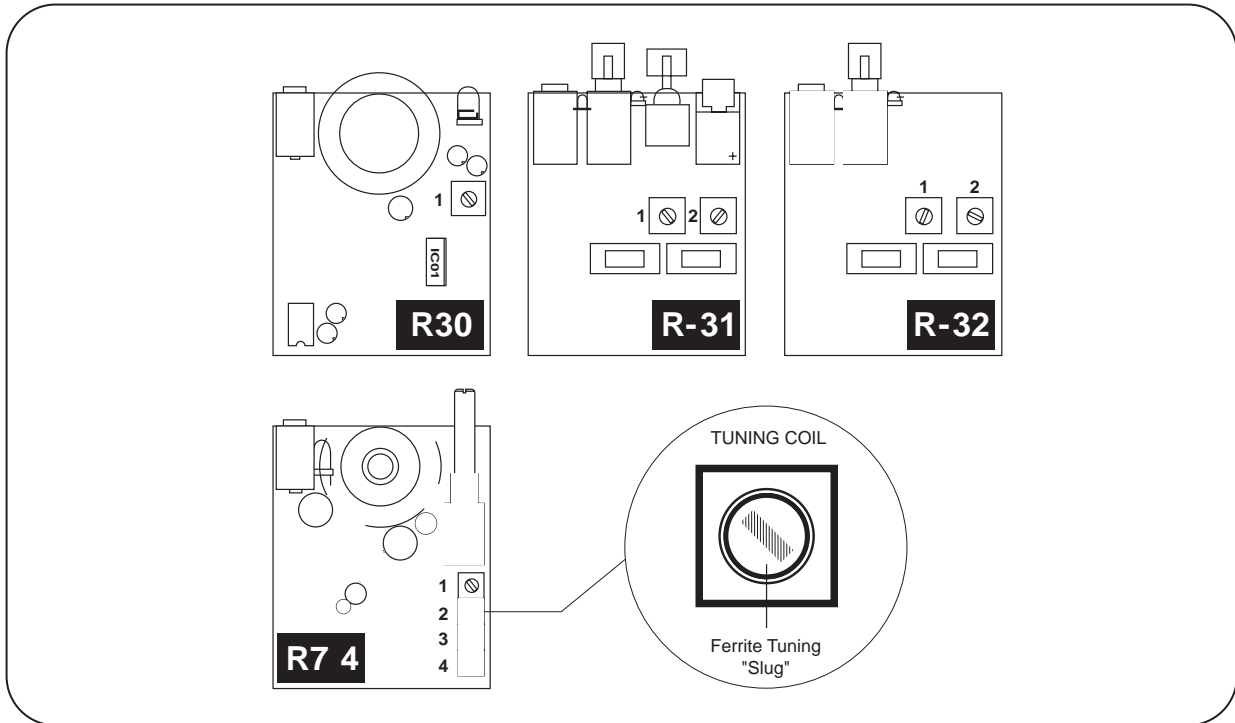

Most Williams Sound single channel Receivers are set at the factory to 72.9 MHz. The standard four-channel receivers (R7-4), channels 1-4, are usually set to frequencies 72.1, 72.5, 72.9, 75.7 MHz respectively.

The Receiver must be tuned with a weak and somewhat noisy signal. If tuned too close to the transmitter, with a strong signal, the most accurate tuning of the receiver is not possible.

TO CHANGE THE FREQUENCY TO ANOTHER CHANNEL:

- Step 1: Set the transmitter to the channel desired and remove the antenna.
- Step 2: Connect an audio source to the transmitter such as a CD or cassette player or microphone or have someone talk into the transmitter's microphone.
- Step 3: Move the receiver about 25 feet away from the transmitter to set the tuning.

HINTS FOR USING THE SYSTEM

Normal operating distance between the transmitter and receiver is about 30 meters. The operating range will vary in different buildings and surroundings. In some locations, the signal may momentarily disappear. This is called a “drop-out” and is due to reflection and cancellation of the radio signal. Moving a few feet will restore the signal.

Keep the transmitter and receiver units at least a meter apart. If the transmitter gets too close to a receiver, it can overload the receiver, causing noisy reception or blocking of the signal.

Do not use more than one transmitter on the same channel (frequency) at the same time unless they are physically separated by more than 30 meters. Operating more than one transmitter on the same channel at the same time in the same place will result in interference.

USING MULTIPLE SYSTEMS FOR MULTIPLE GROUPS:

For multiple tour groups within the same facility, multiple Tour Guide Systems may be operated on the same channel at the same time by maintaining physical separation of 30 meters between groups. The physical separation of groups takes advantage of the FM capture effect which causes receivers to lock onto the closest transmitter.

FIGURE 4: TOUR GUIDE GROUP SEPARATION

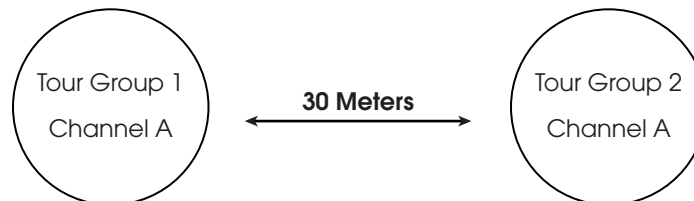

BATTERY INFORMATION

INSTALLATION

Open the battery compartment using a coin in the slot in the bottom of the receiver or transmitter. Press the batteries into place, observing proper battery polarity. Incorrect insertion of the battery is difficult, and if forced, may cause both mechanical and electrical damage to transmitters or receivers not covered by the five year warranty. Units will not work with the battery incorrectly installed.

BATTERY INSTALLATION

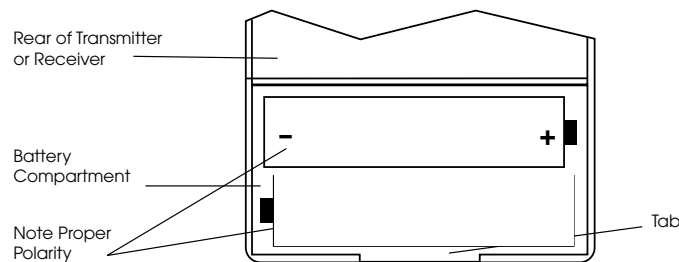

NON-RECHARGEABLE BATTERIES

In normal use, two AA 1.5 V alkaline batteries (BAT 001) will last about 8 hours in the PFM T31 Transmitter and approximately 20 hours in the TGS R30 Receiver. If the sound becomes weak or distorted, replace the batteries. Do not leave dead batteries in the receivers. Battery corrosion is not covered by the Williams Sound five year warranty.

RECHARGEABLE BATTERIES

The PFM T31 Transmitter and TGS R30 Receivers can use rechargeable AA batteries (BAT 026). On an overnight charge, these NiMH batteries are designed to operate a PFM T31 Transmitter for approximately 6 hours, and TGS R30 Receivers for 14 hours.

The battery installed in the receiver may be recharged in the receiver only if it is a NiMH battery, and only if a Williams Sound CHG 1600 Multi-Charger is used. Damage from improper charging is not covered by the Williams Sound five year warranty.

IMPORTANT RECHARGEABLE BATTERY INFORMATION

Rechargeable batteries are shipped in a discharged condition. They must be charged for a complete charge cycle before the first use (approximately 15 hours). Rechargeable batteries will need to be replaced after 1-2 years of use. Do not dispose of batteries in fire. Do not open batteries - toxic chemicals inside.

!! IMPORTANT WARNINGS !!

DO NOT ATTEMPT TO RECHARGE ZINC CARBON ("HEAVY DUTY"), ALKALINE, OR LITHIUM BATTERIES!

DO NOT ATTEMPT TO RECHARGE DISPOSABLE BATTERIES! These batteries may heat up and explode, causing possible injury and damage to the equipment.

Avoid shorting the plus and minus battery terminals together with metal objects. Battery damage and burns can result!

USING THE OPTIONAL CHG 1600 BATTERY CHARGER

With AC power connected, the CHG 1600 Multiple Charger operates in a “trickle charge” mode. Units can be left on trickle charge indefinitely without risk. Pressing the Overnight Charge button switches the charger to a higher-rate, overnight charge mode on a 15 hour timer. After 15 hours, the “Complete / Maintain” light will come on and the CHG 1600 reverts to trickle mode. Any time the button is pressed, the 15 hour timed charge begins again. The CHG 1600 Charger does not monitor individual unit battery state.

Charging Instructions

- Step 1: Plug the power supply into an AC wall outlet. Plug the power connector into the jack on the right side of the CHG 1600’s control panel.
- Step 2: Make sure the units being charged are turned OFF. DO NOT attempt to charge non-rechargeable batteries.
- Step 3: Place the units in the slots so that the charging pins and the unit’s side contacts are coupled. The “CHG” indicator next to the unit will be dimly lit.
- Step 4: When all units are in place, press the red button on the CHG 1600’s control panel. The red “Overnight Charge” indicator on the CHG 1600’s control panel will light during charging, and the “CHG” indicators next to each unit will be brightly lit.
- Step 5: The CHG 1600 will charge the units for approximately 15 hours, then automatically resume a trickle charge. The “Complete/Maintain” indicator will come on.
Units may be fully charged before the green “Complete/Maintain” indicator is lit. Units may remain in the CHG 1600 Multiple Charger for more than 15 hours without harm. Williams Sound rechargeable AA batteries can be charged on a daily or less frequent basis.

USING THE CHG 1600 CHARGER

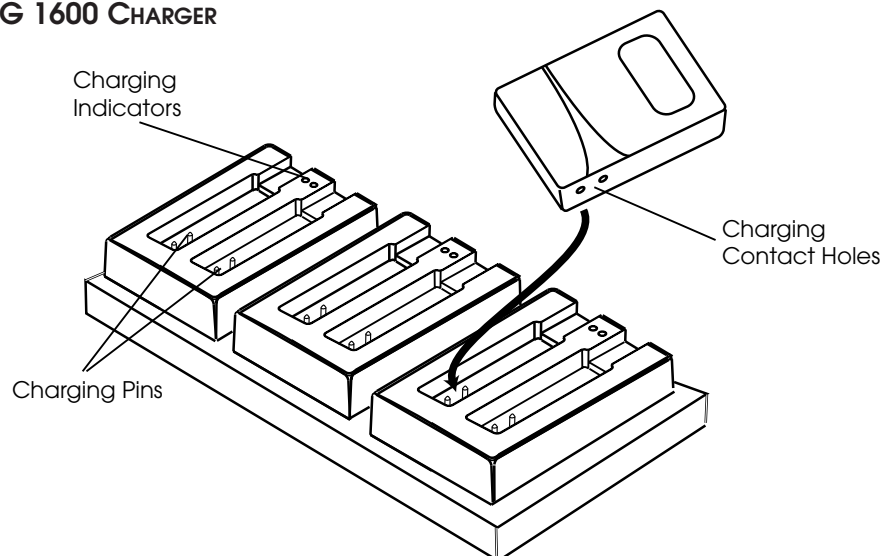

USING THE OPTIONAL CHG 200A BATTERY CHARGER TO CHARGE TRANSMITTERS AND RECEIVERS

- Step 1: Plug the CHG 200's power supply into the Power Input on the charger's side and a standard AC wall outlet.
- Step 2: Route the power cord around the Cord Hook (see figure at right). This will minimize strain on the cord and jack and insure that the power cord is not detached during charging.
- Step 3: Make sure the receivers/transmitters to be charged are turned OFF.
- Step 4: Place the receivers/transmitters in the slots so that the CHG 200's Charging Pins and receiver's side panel contacts are coupled. Make sure that the charging contact holes line up with the charging pins. The receivers should drop easily into the slots. **DO NOT FORCE THEM IN BACKWARDS.**
- Step 5: The Charging Indicators will light, indicating that charging is in process.
- It takes 14–16 hours to fully charge the batteries. Remove the receivers when charging is completed.

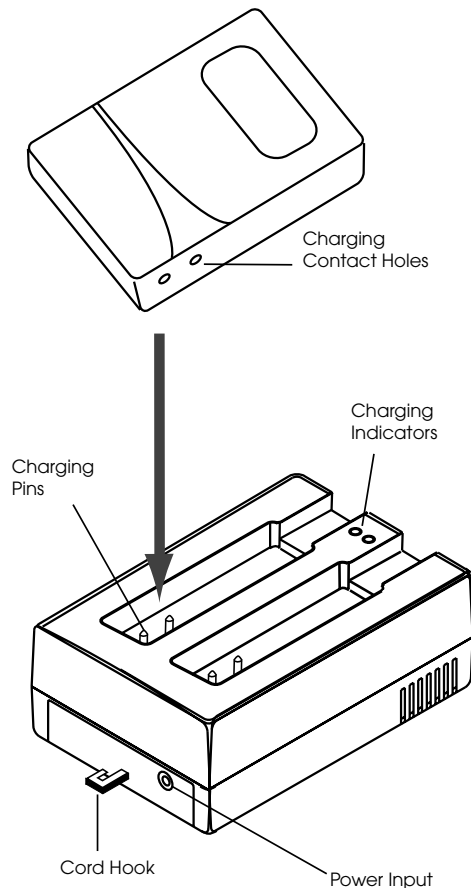

FURTHER SUGGESTIONS

Receivers should always be turned OFF while charging.

It's best to allow the batteries to fully discharge before charging.

If the batteries are near end of life and the LED turns off while the receiver is operating, this is an indication to change or recharge your batteries. Approximately one hour of battery life remains.

Rechargeable batteries will need to be replaced after 1–2 years of use.

!! WARNING !!
DO NOT ATTEMPT TO RECHARGE DISPOSABLE BATTERIES!

The batteries may heat up and burst, causing possible injury and damage to the equipment.

Avoid shorting the plus and minus battery terminals together with metal objects. Battery damage and burns can result!

Use only Williams Sound supplied chargers and batteries.

IN CASE OF DIFFICULTY

If your Tour Guide System is not working, check the following:

1. Read through the manual and user guide carefully to verify proper setup and installation of your system.
2. Make sure the batteries are fresh or completely charged and that the “plus” and “minus” terminals are installed correctly.
3. If the rechargeable batteries will only work for a short period of time (less than 1 hour) even after they are fully charged, they must be regenerated. Leave them in the receiver or transmitter with the unit turned on, for 5 - 6 hours. Then turn receiver or transmitter off, place it in the charger, and charge for 14 - 16 hours. This should restore normal battery life. Rechargeable batteries will gradually lose their capacity over time and should be replaced every year.
4. Make sure the *microphone* is plugged into the PFM T31 Transmitter and the *headphone* is plugged into the TGS R30 Receiver.
5. Move the transmitter and receiver closer together. You may be out of range. When using the system indoors, it's normal for the signal to momentarily disappear in certain locations. This is called a “drop-out.” Moving a few feet will restore the signal.
6. Do not try to use more than one transmitter on the same channel in close proximity to each other. **MORE THAN ONE TRANSMITTER ON THE SAME CHANNEL WILL RESULT IN INTERFERENCE IF THEY ARE CLOSE TOGETHER.** Keep the systems at least 30 meters apart or use separate channels for each system used.
7. If you are still hearing interference on the receivers, turn the transmitter off and listen with a receiver. If you hear the interference with the transmitter off, you need to change to a clear channel. Call your Williams Sound at 1-800-843-3544 for details.

NOTICE

Williams Sound Corp. assumes no liability for improper use or operation of this equipment. The user is cautioned to operate the volume controls at the lowest acceptable level, and in a manner that will not cause damage to hearing. Ear pieces and accessories should be worn using good judgement and for their intended purpose.

Users are cautioned that changes or modifications not expressly approved by Williams Sound Corp. could void the user's authority to operate the equipment.

Limited Warranty

Williams Sound products are engineered, designed, and manufactured under carefully controlled conditions to provide you with many years of reliable service. Williams Sound warrants the FM Tour Guide System against defects in materials and workmanship for FIVE (5) years. During the first five years from the purchase date, we will promptly repair or replace the FM Tour Guide System.

Microphones, earphones, headphones, batteries, chargers, cables, carry cases, and all other accessory products carry a 90-day warranty.

WILLIAMS SOUND HAS NO CONTROL OVER THE CONDITIONS UNDER WHICH THIS PRODUCT IS USED. WILLIAMS SOUND, THEREFORE, DISCLAIMS ALL WARRANTIES NOT SET FORTH ABOVE, BOTH EXPRESS AND IMPLIED, WITH RESPECT TO THE FM TOUR GUIDE SYSTEM, INCLUDING BUT NOT LIMITED TO, ANY IMPLIED WARRANTY OF MERCHANTABILITY OR FITNESS FOR A PARTICULAR PURPOSE. WILLIAMS SOUND SHALL NOT BE LIABLE TO ANY PERSON OR ENTITY FOR ANY MEDICAL EXPENSES OR ANY DIRECT, INCIDENTAL OR CONSEQUENTIAL DAMAGES CAUSED BY ANY USE, DEFECT, FAILURE OR MALFUNCTIONING OF THE PRODUCT, WHETHER A CLAIM FOR SUCH DAMAGES IS BASED UPON WARRANTY, CONTRACT, TORT OR OTHERWISE, THE SOLE REMEDY FOR ANY DEFECT, FAILURE OR MALFUNCTION OF THE PRODUCTS REPLACEMENT OF THE PRODUCT. NO PERSON HAS ANY AUTHORITY TO BIND WILLIAMS SOUND TO ANY REPRESENTATION OR WARRANTY WITH RESPECT TO THE FM TOUR GUIDE SYSTEM. UNAUTHORIZED REPAIRS OR MODIFICATIONS WILL VOID THE WARRANTY.

The exclusions and limitations set out above are not intended to, and should not be construed so as to contravene mandatory provisions of applicable law. If any part or term of this Disclaimer of Warranty is held to be illegal, unenforceable, or in conflict with applicable law by a court of competent jurisdiction, the validity of the remaining portions of this Disclaimer of Warranty shall not be affected, and all rights and obligations shall be construed and enforced as if this Limited Warranty did not contain the particular part or term held to be invalid.

If you experience difficulty with your system, call Toll-Free for Customer Assistance:

1-800-843-3544

If it is necessary to return the system for service, your Customer Service Representative will give you a Return Authorization Number (RA) and shipping instruction.

Pack the system carefully and send it to:

**Williams Sound Corp.
Attn: Repair Dept.
10321 West 70th Street
Eden Prairie, MN 55344 USA**

Your warranty becomes effective the date you purchase your system. Your returned warranty card is our way of knowing when your warranty begins. It also gives us important information about your system including the serial number. This information will help us serve you better in the future. Please take a moment to complete and mail the attached card. Thank you.

SYSTEM SPECIFICATIONS

PFM T31 TRANSMITTER:

Dimensions:	3-5/8" L x 2-3/8" W x 7/8" H (92.1 mm x 60.3 mm x 22.2 mm)
Weight:	4.4 oz (125 g) with battery
Color:	Royal blue, shatter-resistant polypropylene
Battery Type:	Two (2) AA 1.5 V non-rechargeable Alkaline batteries (BAT 001), 70 mA nominal current drain, 12 hours approx. life (OR) two (2) AA 1.5 V NiMH rechargeable batteries (BAT 026), 70 mA nominal current drain, 10 hours per charge approx., recharges in 14-16 hours, uses CHG 200 Charger
Operating Freq's:	Selectable, 13 channels, 72.1-75.9 MHz, internal DIP switch
Stability:	+ .005%, frequency synthesized, crystal reference, PLL
Modulation:	Wide-band FM, 75 kHz, 75 μ S pre-emphasis
RF Output:	8000 μ V/m at 30 m, max., 40 mW typical
FCC ID:	CNM T30
Freq Response:	100 to 10 kHz, + 3 dB at 1% max. THD
Signal-to-Noise Ratio:	55-60 dB, with R31 or R32 Receiver
Auto Gain Control:	40 dB range, 30 mV threshold
Transmit Antenna:	Integral with 39" microphone cord
Microphone:	Directional condenser, noise canceling, 39" cord, 3.5 mm mono plug (MIC 086)
Controls:	On/Off switch, slide-type, Mute switch, slide-type
Mic Connector:	3.5 mm mono jack
Warranty:	5 years, parts and labor (90 days on accessories)

TGS R30 RECEIVER:

Dimensions:	3-5/8" L x 2-3/8" W x 7/8" H (92.1 mm x 60.3 mm x 22.2 mm)
Weight:	4.6 oz (130 g) with batteries
Color:	Gray
Battery Type:	Two (2) AA 1.5 V non-rechargeable Alkaline batteries (BAT 001), 14 mA nom. current drain, 80 hours approx. life (OR) two (2) AA 1.5 V NiMH rechargeable batteries (BAT 026), 14 mA nominal current drain, 50 hours per charge approx., recharges in 14-16 hours, uses CHG 1600 Charger or CHG 200 Charger
FCC ID:	CNM R30
Industry Canada Cert.:	13601021234
Operating Freq.:	Pre-tuned, adjustable, 72 MHz-76 MHz *
Intermediate Freq.:	75 kHz
FM Deviation:	75 kHz
De-Emphasis:	75 μ S
AFC Range:	\pm 120 kHz
Sensitivity:	4 μ V at 12 dB Sinad with squelch defeated
Input Overload:	20 mV
Frequency Response:	100-10 kHz, \pm 3 dB
Signal-to-Noise Ratio:	50 dB at 10 μ V
Receive Antenna:	Integral with earphone/headphone cord
Audio Output:	35 mW, max. at 16 Ω
Output Connector:	3.5 mm mono phone jack
Headphone:	Deluxe folding headphone, 3.5 mm plug, 1m cord (HED 021)
Notes:	The R30 Receiver can be field tuned to any of 10 wideband channels using the PLT 005 Tuning Tool.
Warranty:	5 years, parts and labor (90 days on accessories)

*FCC rules limit the use of the 72-76 MHz band to hearing assistance for the handicapped only.

NOTE: SPECIFICATIONS SUBJECT TO CHANGE WITHOUT NOTICE



Williams Sound Corp.
10321 West 70th St., Eden Prairie, MN 55344
U.S.A. 800-328-6190 / 952-943-2252 / FAX: 952-943-2174

www.williamssound.com

© 2005, Williams Sound Corp.

MAN 118B