



Installation Guide & User Manual

SoundPlus® WIR TX300 Infrared System

Large Area Infrared Listening System

Modulator Model WIR MOD 1
Transmitter Model WIR TX3
Receiver Models WIR RX1, RX3, RX4

 **Williams Sound**®
Helping People Hear



SoundPlus® WIR TX300 Infrared Listening System Installation and User Manual

| Contents: | Page |
|---|-------------|
| Introduction | 4 |
| Controls and Features | |
| MOD 1 Front Panel | 5 |
| MOD 1 Rear Panel | 5 |
| TX3 Transmitter | 6 |
| Infrared Transmitter Setup | |
| Selecting a Transmitter Location | 7 |
| Mounting TX3 Transmitter To Wall or Ceiling | 8 |
| Transmitter Power Wiring | 9 |
| 95 kHz Carrier Cable Connection | 10 |
| Modulator Installation | |
| Power Connection | 10 |
| 95 kHz Carrier Cable Connection | 11 |
| Audio Source Connection | 11 |
| Using a Microphone | 11 |
| Hi-Pass Filter Setting | 11 |
| Testing the System | 12 |
| Receiver Instructions | 12 |
| Battery Information | 13 |
| Suggestions For Receiver Management | 14 |
| Troubleshooting | 14 |
| Warranty | 14 |
| Specifications | 15 |

Note: Taking a few minutes now to read these instructions will save time and ensure proper system operation.

Introduction

The Williams Sound WIR TX300 Infrared System consists of a MOD 1 Modulator and one or more TX3 Transmitters (also called emitters) which use invisible infrared (IR) light waves to broadcast speech or music to wireless infrared receivers. The Modulator accepts a variety of audio inputs and sends a 95 kHz frequency modulated signal to the Transmitter via a coaxial cable. The Transmitter emits invisible infrared light into the listening area. Infrared receivers detect the transmission and convert the light signals back into audio signals.

The system is designed to broadcast high quality audio for hearing assistance and language translation applications. Because the system uses infrared light for transmission, it is not affected by interference from radio equipment and does not interfere with radio equipment.

A single TX3 infrared transmitter will cover approximately 10,000 square feet of listening area. Larger areas can be covered with additional transmitters. The transmission is confined within opaque walls if security is an issue, such as courtrooms and corporate boardrooms. The Williams Sound Infrared System can also be used where multiple systems are needed in adjacent rooms, such as movie theaters and conference centers, without “spillover” from adjacent rooms.

The system can be used with a microphone as a stand-alone system, or it can be connected to an existing sound system. Infrared Systems cannot be used in bright sunlight, which contains large amounts of interfering infrared light.

Fig. 1: Typical System Configurations

(1) Modulator and (1) Transmitter

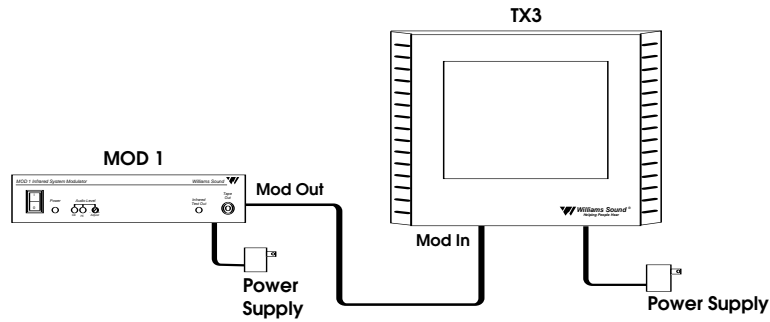

(1) Modulator and (2) Transmitters

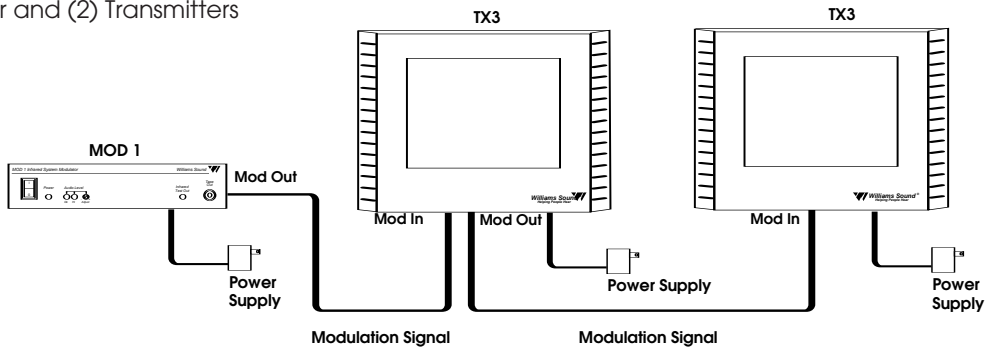

Controls and Features:

MOD 1 Front Panel

Power Switch:

Turns modulator power on/off.

Power Indicator:

Green LED indicates power on.

Audio Level Indicators:

“Ok” amber LED indicates proper audio input level.

“Hi” red LED indicates excessive audio input level.

Audio Level Control:

Screwdriver rotary adjustment for audio input level.

Infrared Test LED:

Infrared LED provides a modulated IR signal for receiver testing, monitoring, audio source testing.

Tape Output:

RCA Jack provides unbalanced, line-level audio output signal for tape recorders, etc.

MOD 1 Rear Panel

Balanced Microphone-Level Input:

Female XLR jack for use with low impedance (150 - 200Ω) microphones. Supplies simplex DC power per DIN 45596 for condenser microphones.

Balanced Line-Level Input:

Female XLR jack for balanced, line-level inputs. Can also accept unbalanced input, and 4Ω, 8Ω, or 16Ω speaker line.

70V (Hi-Level) Input:

Female XLR jack for direct connection to a 70V or 25V speaker line.

Input Level Switch:

Three-position switch selects mic-level, line-level, or 70V input for the XLR input jack.

Unbalanced Audio Inputs:

Two RCA jacks for unbalanced line-level audio inputs. Inputs are mixed internally with the balanced input signal.

High-Pass Filter:

Three position switch provides 6dB/octave low-frequency roll-off to reduce noise, improve speech intelligibility, compensate for typical high-frequency hearing loss.

Modulator Outputs:

Two F-type connectors provide 95 kHz frequency modulated outputs to feed two TX3 Transmitters.

Power Input:

Two-screw terminals for low-voltage power supply, 24VAC, 50 or 60Hz, 2.4VA.

Fig. 2: MOD 1 Front & Rear Panels

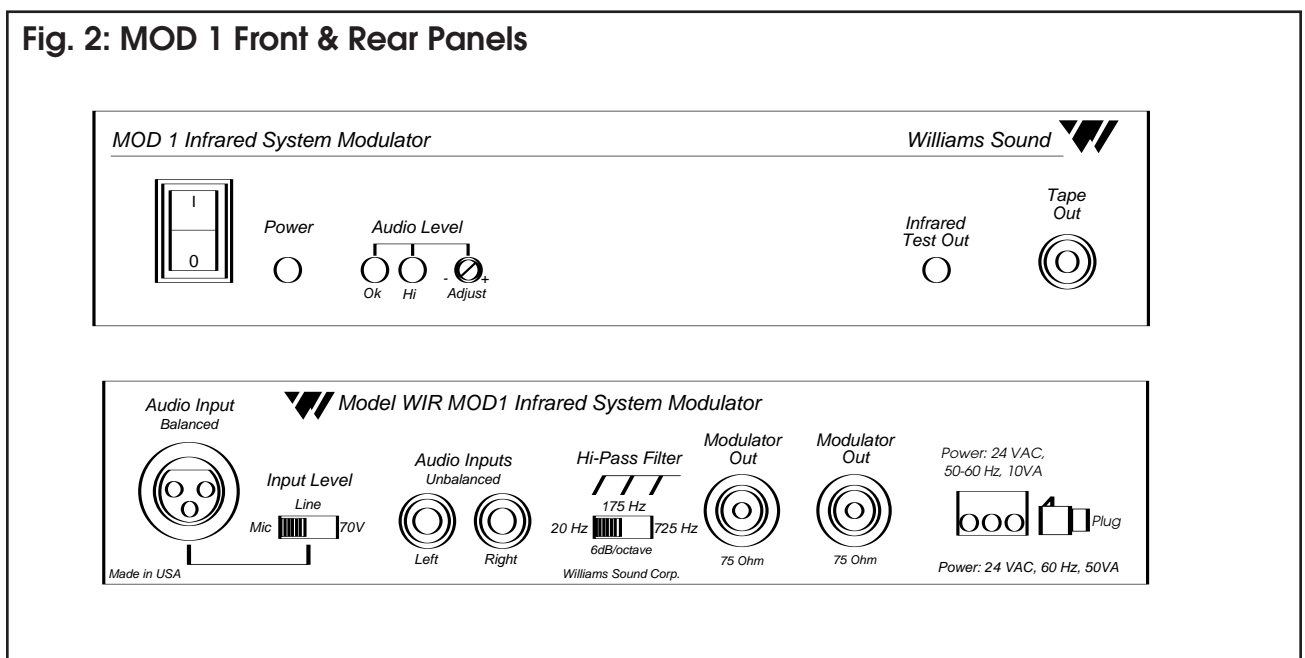
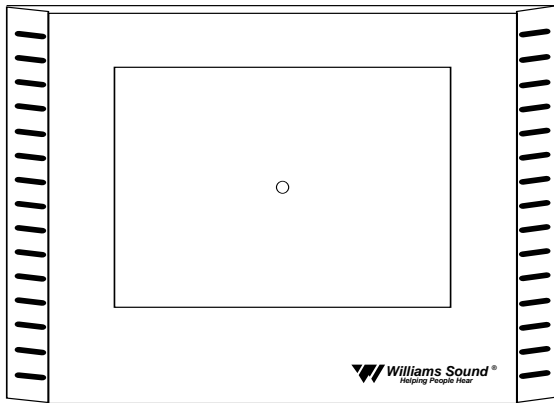
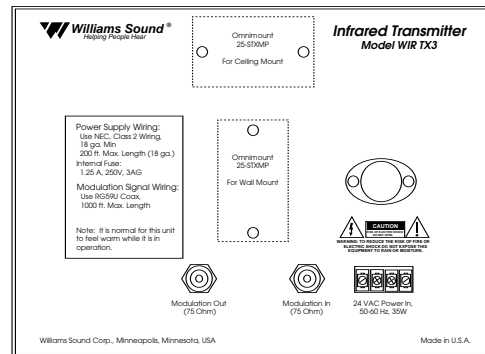

Fig. 3: TX3 Front & Rear



TX3 Front



TX3 Rear

TX3 Transmitter

Power Input:

Two-screw terminal strip for low-voltage power supply. 24VAC, 50 or 60Hz, 50VA. Each TX3 requires a separate power supply.

Power Indicator LED (front panel):

Located on the front panel in the center of the LED window. Red indicator light glows when power is on and the 95 kHz carrier is present.

NOTE: The TX3 shuts off when no 95 kHz carrier is present.

Modulation In:

Connects to the Modulator Out jack of the MOD 1 modulator or another TX3 transmitter.

Modulation Out:

Connects to the Modulation In jack of the next TX3 transmitter in the chain when multiple transmitters are used.

Mounting Bracket:

An omnidirectional mounting bracket is included with the Transmitter. Positions are indicated for wall and ceiling mounts. An optional tripod stand kit is also available (WSC Part #SS-2).

Step 1: Infrared Transmitter Set-Up

Selecting a Transmitter Mounting Location

- Rule 1: The Williams Sound Infrared System should not be installed outdoors or indoors where there is considerable direct sunlight. Sunlight generates infrared interference. Certain types of high-efficiency fluorescent lighting use 100kHz modulation that can also interfere with infrared systems.
- Rule 2: The most important principle to understand when installing an infrared system is that invisible infrared light behaves just like visible light. It does not pass through opaque objects like walls and curtains and people. It does pass through windows and door openings and it can bounce and scatter off reflective walls, floors, and ceilings. The IR transmitter panels cannot be concealed or covered up. The IR “eye” on the receiver unit cannot be covered up and works best with a clear line-of-sight to the transmitter panel(s).
- Rule 3: If you are not getting sufficient coverage with a properly installed transmitter panel, you need to add one or more additional transmitter panels.

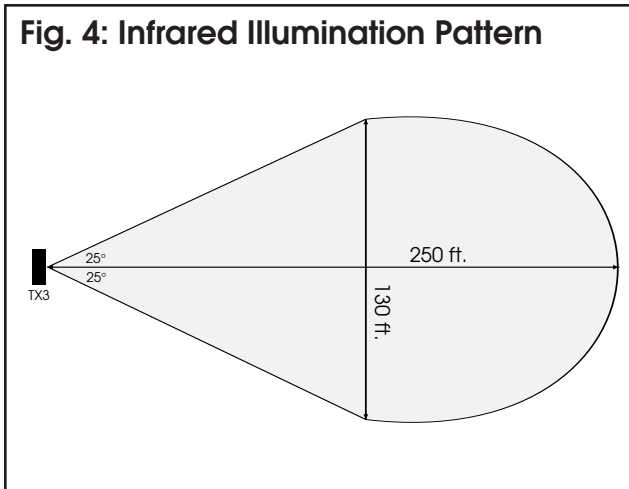

Figures 4, 5, and 6 illustrate infrared light patterns and recommended transmitter locations. In listening areas up to 10,000 square feet, the TX3 transmitter panel should be installed on the left or right side of the front wall of the listening area. It needs to be above the audience to permit a direct line of sight between the transmitter and people wearing receivers when the people are standing or sitting.

It's helpful to think of the IR transmitter as an invisible floodlight. You want to aim it so listeners are "flooded" with infrared light.

Many listening areas will require two IR transmitters for complete coverage. Place one transmitter panel on the left side of the front wall and the other on the right hand side. The two transmitters will be connected together with a coaxial cable.

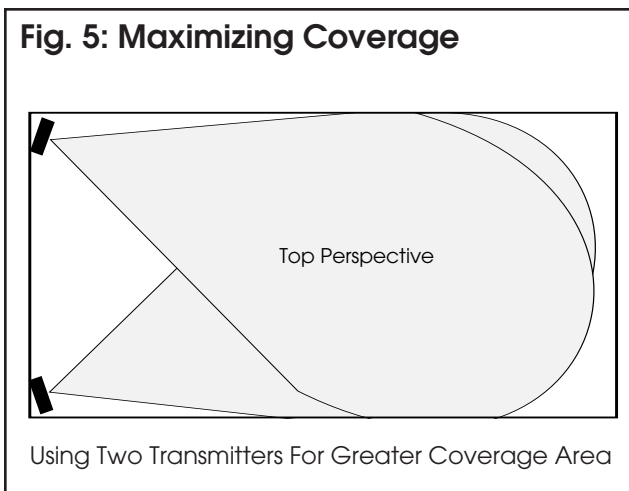

The infrared illumination pattern from a single transmitter is a cone-shaped beam, with a 50° angle. The horizontal and vertical patterns are identical. Figures 4 and 5 show examples of coverage patterns.

These patterns are the direct radiation pattern. The infrared radiation does not drop to zero outside the illustrated patterns; it decreases. It still may be useable at a greater distance, depending on receiver sensitivity and reflection characteristics of the room.

Infrared light reflects off light-colored surfaces and scatters, which increases the coverage area. Dark colored surfaces tend to absorb infrared light, minimizing reflections, and limiting coverage to the direct illumination pattern. It's O.K. (and desirable) for the illumination patterns to overlap when

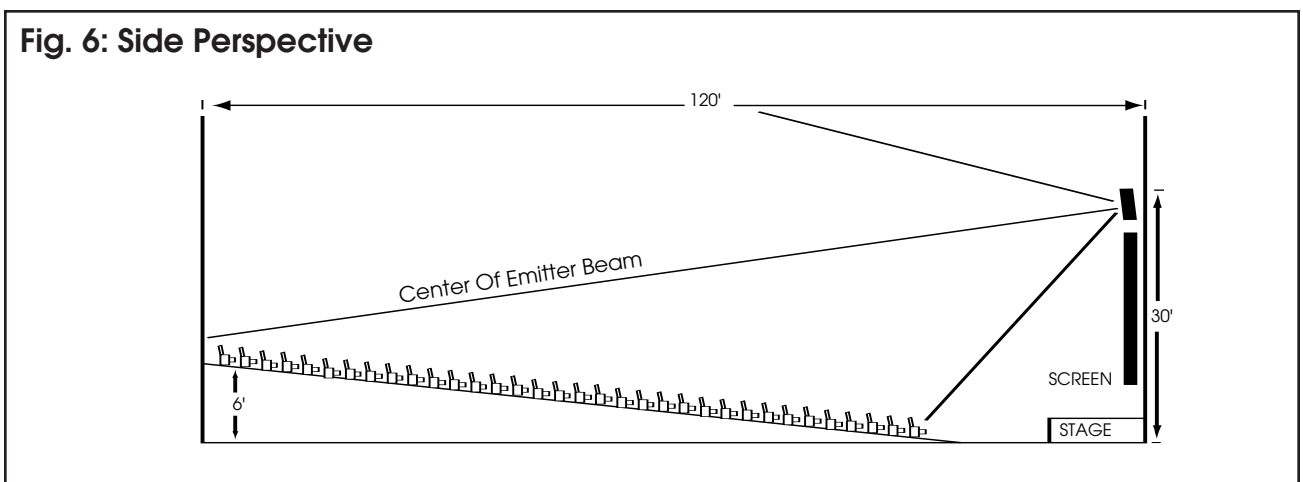

multiple transmitters are used. Placing the transmitter high above the audience (15 to 30 feet) and aimed slightly downward (5 to 15°) will ensure the longest “throw” of the infrared beam. Angling the transmitter inward towards the center of the room also increases the coverage of the seating area.

Remember that opaque objects block the infrared light. Thus, transmitters cannot be concealed behind an opaque walls, curtains, etc. Neither should transmitters be used in areas of extreme high or low temperatures, humidity, or chemical environments.

Mounting the TX3 to a wall or ceiling:

Step 1: Use the 5/32" allen wrench to loosen the tension bolt in the clamp assembly enough to release the ball. **DO NOT** unscrew the tension bolt completely. Using the mounting plate as a template, mark the hole locations on the mounting surface. Use fasteners appropriate for the mounting surface (wood screws, lag bolt, wall anchor) to attach the mounting plate. Recommended fastener size is 1/4".

Step 2: Attach the clamp plate to the rear of the transmitter, using (2) 1/4 x 20 x 1/2" socket head screws and 3/16 hex wrench provided. Place the mounting plate in the position indicated for ceiling or wall mounting.

Step 3: Place the transmitter/clamp plate assembly onto the the mounting plate ballshaft. Aim the transmitter at the desired downward angle and support it fully while using the hex wrench to tighten the tension screw. After initial installation, the ball will slowly compress under pressure. Check the tension screw after 15 minutes and re-tighten if necessary. **DO NOT** over-tighten.

If rotational adjustment is required, use a 7/16" open-end wrench to loosen the jam nut on the ballshaft. Rotate the transmitter and re-tighten the jam nut.

Fig. 7: SB-3 Wall/Ceiling Mount

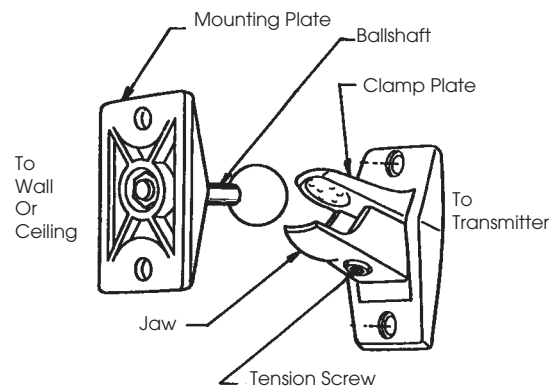

Fig. 8: Bracket 012 Ceiling Mounting

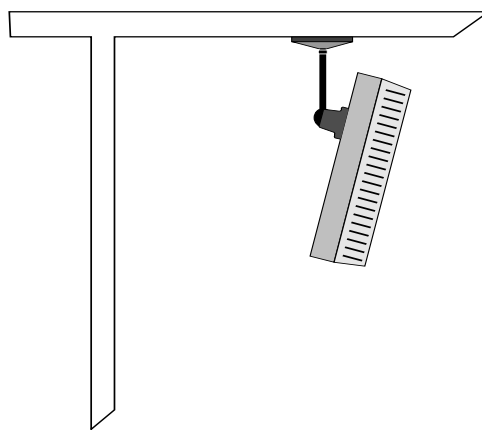
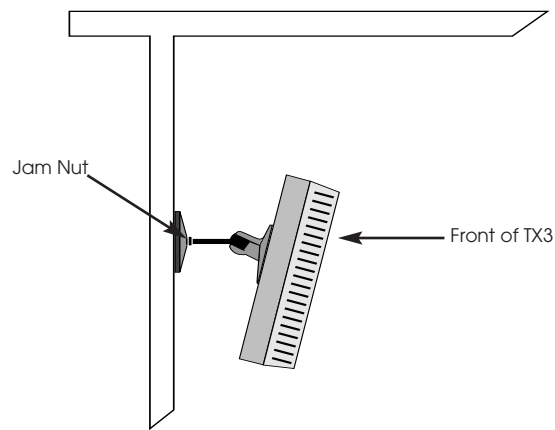

Fig. 9: Bracket 012 Wall Mounting



Step 2: Transmitter Power Wiring

WARNING! BE SURE AC POWER IS TURNED OFF AT THE OUTLET WHILE INSTALLING THE POWER TRANSFORMER. A METAL COVER PLATE COULD SLIP AND SHORT ACROSS THE TRANSFORMER PLUG DURING INSTALLATION, CREATING A SHOCK HAZARD.

SHORTING THE POWER SUPPLY TERMINALS WILL BLOW A NON-REPLACEABLE INTERNAL FUSE, DESTROYING THE POWER SUPPLY UNIT!

The TX3 transmitter is supplied with a low-voltage wall transformer power supply. The transmitter must be located within 6 feet of an AC wall outlet or the 24 Volt power cord must be extended. Additional two-conductor, 18 ga. zipcord is included with the transmitter. If the transmitter power supply can be located near the modulator, use the combination cable to carry the modulation signal and low-voltage power to the transmitter. The zipcord can be separated from the combination cable if the power supply is located near the transmitter.

DO NOT CONNECT THE POWER SUPPLY TO AC POWER YET!!!

Step 1: Determine the length of zipcord needed to reach from the transmitter to the AC wall outlet where the power supply will be plugged in. Cut the zipcord to length. Zipcord length must not exceed 200 feet. Strip the ends and install the crimp-on

spade terminals supplied. Connect one end of the zipcord to the transmitter power input screw terminals. Connect the other end to the power supply screw terminals.

Step 2: Make sure to switch AC power to the outlet OFF at the fuse or circuit breaker. Remove the wallplate cover screw and plug the transformer into the outlet. Secure the transformer with the cover plate screw. Turn the AC power back on at the breaker box AFTER the transformer is installed.

The indicator light on the front panel of the TX3 will not glow unless there is a 95 kHz carrier. This auto shut-off feature preserves the life of the IR LED's and reduces power consumption when the transmitter is not in use. The wall transformer can be plugged into a switched outlet that turns on when the other sound equipment is turned on. This system is designed for Class 2, low-voltage wiring. Always follow local electrical codes when doing low voltage wiring.

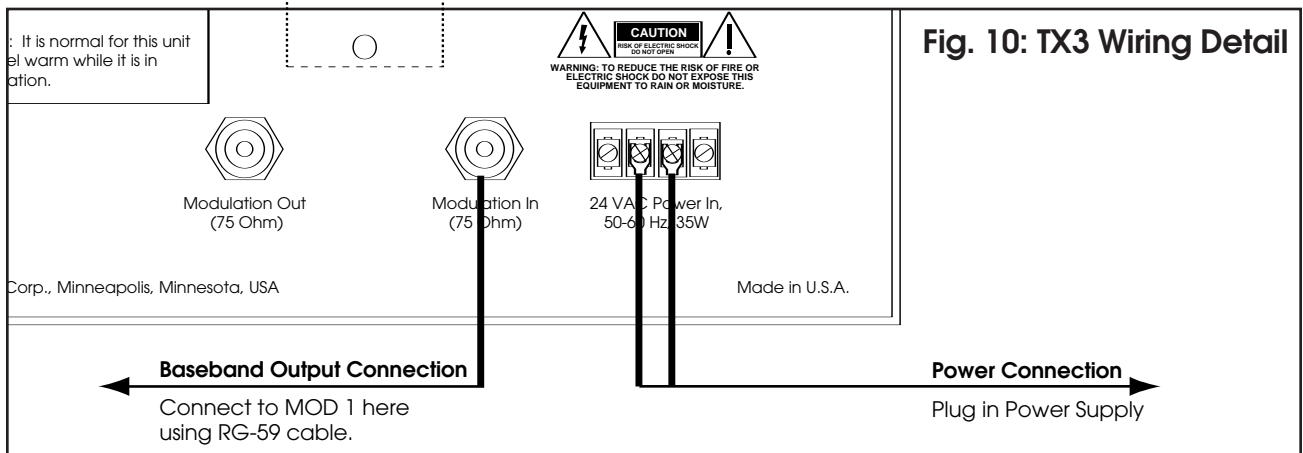

Step 3: 95 kHz Carrier Cable Installation

- Step 1:** Determine the length of RG59 coaxial cable needed to reach from the transmitter to the modulator unit. The modulator is usually located near the other sound equipment to simplify audio connections. 100 feet of coaxial cable is included with each transmitter. You will need to cut it to length and install F-connectors on both ends. Additional RG59 coax can be added, up to 1000 feet maximum. Make sure you leave some slack at each end.
- Step 2:** Install the F-connectors on each end of the cable. You will need a CATV-type coax stripper and crimper.
- Step 3:** Connect the 95 kHz carrier cable to either Modulator Out jack on the MOD 1 modulator and to the Modulator In jack on the TX3 transmitter.

If you are using more than one transmitter:

- Step 1:** Determine the length of coaxial cable needed to reach between the transmitters. 100 feet of coaxial cable is included with each transmitter. You will need to cut it to length and install F-connectors on both ends. Additional RG59 coax can be added, up to 1000 feet maximum. Make sure you leave some slack at each end.
- Step 2:** Install the F-connectors on each end of the cable. You will need a CATV-type coax stripper and crimper.

- Step 3:** Connect the modulation cable from the Modulation Out Jack on the first transmitter in the chain (the one connected to the MOD 1 Modulator) to the Modulation In jack on the next TX3 transmitter in the chain. Use the cable clamps and screws provided to secure the cable. The coax can also be routed through conduit. You can chain as many transmitters together as you need. Remember that each transmitter needs its own power supply.

Fig. 11: Modulator Wiring Detail

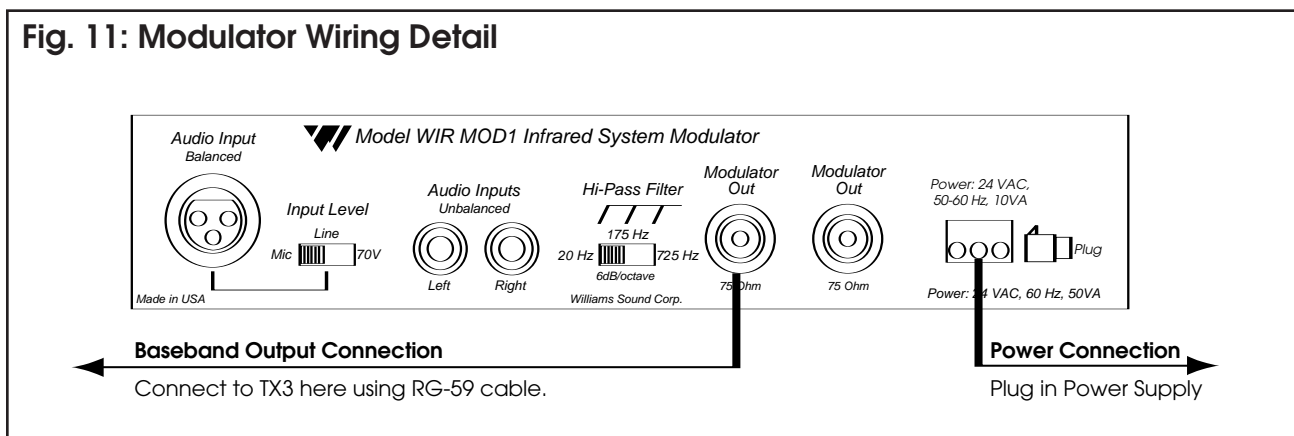

Step 4: MOD 1 Modulator Installation

Location:

The Modulator is usually located near the sound system amplifier or mixer for easy access to an audio input signal. For portable systems, the modulator can be placed near the transmitter or wherever is most convenient.

Power Connection

Step 1: Connect the power supply wires to the two center screw terminals on the terminal block located on the rear of the Modulator.

Step 2: Plug the power supply into an AC outlet.

95 kHz Cable Connection

Connect the coaxial cable to either F-type “Modulator Out” jack on the MOD 1. For systems having multiple transmitters, both modulator outputs can be used to run a separate coax cable to transmitters on each side of a stage, screen, etc. The MOD 1 drives one transmitter per modulator output. The transmitters then repeat the 95 kHz signal, so any number of transmitters can be used. The modulator outputs CANNOT be split with CATV splitters.

Audio Connection

Mono, Unbalanced Source:

Use the RCA to RCA audio cable supplied to connect either MOD 1 unbalanced “Audio Input” jack to an appropriate unbalanced, line-level audio output jack on the sound system mixer or amplifier. Suitable connections are:

1st Choice: TAPE OUT or LINE OUT Jack

2nd Choice: BOOSTER or BRIDGING Jack

If your amplifier or mixer does not have RCA-type connectors, you can obtain adaptors from your Williams Sound Authorized Dealer or a local radio parts store. If the TAPE OUT jack is already in use, a Y-Cord can be used to connect the MOD 1 and a second device to the same jack.

Stereo, Unbalanced Source:

For stereo sources, use an additional RCA to RCA cable and connect the left and right signals to the two inputs on the MOD 1. They will be mixed into a mono signal for transmission.

Three-Channel, Unbalanced Source

(Left, Right, Center Channel):

Set the input level switch to “Line.” Use the two unbalanced inputs and the XLR balanced input. You will have to make an RCA to XLR adaptor cable. To unbalance the XLR input, wire XLR pin 2 to the positive audio pin on the RCA plug and wire XLR pin 1 and pin 3 together to the audio ground sleeve on the RCA plug. The three signals will be mixed into a mono signal for transmission.

Balanced, Line-Level Source:

Set the Input Level Switch to “Line.” The XLR input jack can be connected to any balanced, line-level audio signal. It has an input impedance of 100 KOhms, so it will not load the signal.

Balanced, Microphone Source:

Set the Input Level switch to “Mic.” Any low-impedance, balanced microphone can be plugged into the XLR input jack. Simplex power is supplied for condenser microphones.

4 or 8 Ohm Speaker Line Source:

Set the Input Level Switch to “Line.” Wire an adaptor cable with the positive speaker line connected to XLR pin 2. Connect the negative or ground speaker line to XLR pin 3.

25 or 70V Speaker Line Source:

Set the Input Level Switch to “70V.” Wire an adaptor cable with the positive speaker line connected to XLR pin 2. Connect the negative or ground speaker line to XLR pin 3.

Hi-Pass Filter Setting

The normal setting is the center (175Hz) position. For language interpretation or visual description, the 20Hz setting can be used. For hearing assistance, the 725Hz setting can be used to compensate for typical high-frequency hearing loss. Ask the users what sounds best to them.

Step 5: Testing the System

- Step 1: After the 95 kHz carrier cable, power cables, and audio source are connected, turn the MOD 1 power switch on. The green LED on the front of the MOD 1 should light.
- Step 2: Make sure the sound system is on and your audio source is active. Adjust the Audio Level control on the front of the MOD 1 until the “OK” light flashes with the audio signal. It is okay if the red “Hi” light flashes occasionally, but it should not stay lit constantly. If you can't get the “Ok” light to come on, make sure the Input Level switch is set properly. If it is, you need to boost the signal source.
- Step 3: Look at the transmitter panel(s). With the modulation signal and power connected, a red light should be visible in the center of the panel.
- Step 4: Hold a receiver near the “Infrared Test Out” hole on the front of the MOD 1. Turn the receiver on and adjust the volume. You should be able to hear the audio signal through the receiver. If not, make sure the audio “Ok” light is still flashing. If the light is not flashing, check your audio source or the setting of the input level switch and input level control. If the audio light is flashing, but you don't hear anything from the receiver, try a different receiver to make sure the receiver is working.
- Step 5: Take a receiver into the listening area and walk around to check the reception. Make sure the “eye” on the receiver is not covered up when in use. The receiver will not work if it is placed in a pocket or purse. The receiver eye must be able to “see” the transmitter panel. It may be necessary to adjust the angle of the transmitter(s) to obtain the best coverage. If coverage is not adequate, additional transmitter panels must be used.

Receiver Operating Instructions

Receiver Model WIR RX1

The RX1 is a stethoscope-style receiver with built-in earphones. Make sure the “eye” on the front of the receiver is not covered up when in use. The receiver is intended to be worn on the front of the body, hanging from the ears.

- Step 1: **Battery Installation:** The RX1 uses two AAA Alkaline batteries. To insert, remove the cover, press the batteries into place, then replace the cover.
- Step 2: Turn the power on by rotating the volume control. Continue rotating until a comfortable volume level is reached. To avoid draining the battery, make sure the receiver is turned off when not in use.

Receiver Model WIR RX3

Make sure the “eye” on the front of the receiver is not covered up when in use. The receiver is intended to be worn on the front of the body, hanging from the lanyard attached to the receiver. The receiver will not work if it is placed in a pocket or purse. A variety of earphones, headphones, or a neckloop telecoil coupler can be used with the RX3 Receiver.

- Step 1: **Battery Installation:** Open the battery compartment by lifting the tab at the bottom of the receiver. Press the battery into place, observing proper battery polarity.
- Step 2: Plug the earphone or headphone into the earphone jack.
- Step 3: Turn the receiver on by rotating the volume control in the direction of the arrow on top of the case. Turning the knob in the direction of the arrow will increase the volume. Turning the knob against the arrow will decrease the volume. To avoid draining the battery, make sure the receiver is turned off when not in use.

Receiver Model WIR RX4

The RX4 is a headset-style receiver. Make sure the “eye” on top of the receiver is not covered up when in use.

- Step 1: Battery Installation: Open the battery compartment by sliding the battery door open on the earpiece. Press two AAA batteries into place, observing proper battery polarity. Slide the battery door closed, taking care not to crush the plastic locking tabs.
- Step 2: Turn the power switch on top of the receiver on. Adjust the volume control wheel located on the bottom of the headset.

Battery Information for Receivers

For the RX3 Receiver in normal use, a heavy-duty 9 Volt battery such as the Eveready 216 will last about 10 hours. Alkaline batteries such as the Eveready 522 will provide about 17 hours of use. For the RX4, alkaline AAA batteries will last about 20 hours. If the sound becomes weak or distorted, replace the battery. The indicator light may still be on, even with a battery that is weak. Do not leave dead batteries in the receivers, they may leak and damage the receiver.

Rechargeable Batteries:

The RX3 receivers can also use a rechargeable battery. We recommend only the 7-cell, 8.4 Volt types

(BAT 003). A fully-charged battery (Williams BAT 003) will provide about 5 hours of use per charge. The battery may be recharged without removing it from the receiver.

The BAT 005 Single Charger has a cord that plugs into the receiver “EAR” jack to charge the battery. The CHG 1269 Multiple Charger can charge 12 receivers simultaneously through the receiver “EAR” jacks.

The receiver should always be turned OFF while charging. It takes about 14 hours to fully charge the battery. If the battery is providing very short service life (under 1 hour of use) let it drain completely by

leaving the receiver on for several hours and then immediately recharge it.

Receivers can be left charging continuously when not in use.

DO NOT ATTEMPT TO RECHARGE DISPOSABLE BATTERIES!

AVOID SHORTING PLUS AND MINUS BATTERY TERMINALS TOGETHER WITH METAL OBJECTS. BATTERY DAMAGE AND BURNS CAN RESULT!

DO NOT MIX RECHARGEABLE BATTERIES & CHARGERS FROM DIFFERENT MANUFACTURERS.

Suggestions for Receiver Management:

Different types of facilities will use different approaches for receiver management and earphone sanitation. Following are some alternatives that other customers have used successfully:

1. Regular users purchase their own receiver and take care of their own batteries and earphone.
2. Some facilities label the receiver and earphone with the names of regular users so each person uses the same receiver and earphone.
3. Ushers issue receivers to people who request them. Earphones are sanitized after use. Foam ear cushions can be replaced or washed with a mild detergent, rinsed thoroughly and air-dried. The EAR 022 Surround Earphone can be sanitized with an alcohol pad.
4. The receivers are stored in a multiple compartment storage case with a credit card or driver's license left as collateral for the receiver.
5. Regular users purchase their own earphone or headphone and bring them to use with receivers at the facility.

Troubleshooting:

Transmitter “Power” light not on.

1. Make sure the wall transformer is plugged into the transmitter and the power switch or any remote power switch is on..
2. Make sure the electrical outlet is on.
3. Make sure the MOD1 is on. The TX3 shuts off when there is no 95kHz modulation signal.
4. Make sure the 24VAC power supplies are working.

No sound through receivers.

1. If some of the receivers work but others don't, check for bad batteries or earphones on the receivers that aren't working.

2. If none of the receivers work, check to see if the power and 95 kHz carrier cable are connected to the transmitter and the “Power” like is ON.
3. Check to see if the modulator is connected properly to the sound system. The audio level lights should be flashing on the modulator.
4. Make sure the “eye” is not covered up on the receiver. There must be clear line of sight between the receiver eye and the transmitter panel.

Sound through the receivers is weak and noisy.

1. Hold a receiver in front of the Infrared Test LED on the front of the MOD 1 modulator and listen to the signal. If the signal is weak and noisy here, check the Input Level switch and Input Level Control settings. Increase the input signal level from the sound system by turning up a mixer control. If the signal sounds okay, you may need to re-position the transmitter panels or add additional panels.

Buzzing or humming noise in sound system.

1. Check for ground loops or noise on the input signal. Call your Authorized Dealer or Williams Sound for help.

Warranty

Williams Sound Transmitters and Receivers are warranted against defects in workmanship and materials for FIVE YEARS. Microphones, earphones, cables, carry cases, rechargeable batteries and chargers are warranted against defects in workmanship and materials for 90 DAYS. This warranty does not extend to intentional or accidental physical damage. This warranty applies only to products returned to Williams Sound for service. To return a product for service, call Williams Sound Corp. at 1-800-843-3544 and request a Return Authorization (RA) number.

SoundPlus™ WIR TX300 Infrared Listening System Specifications

Infrared Audio Processor/Modulator, Model MOD 1

| | | | |
|---|--|-----------------------|---|
| Dimensions, Weight: | 8.45" (21.5 cm) W x 8.18" (20.8 cm) D x 1.72" (4.4 cm) H, 3 lbs. (1.5 kg) | Rear Panel: | |
| Color: | Black epoxy paint with white legends | Audio Inputs: | All three inputs are actively mixed into a single signal, allowing use of mono, stereo, or 3 channel audio sources |
| Rack Mount: | One IEC rack space high, one or two units can be mounted in a single rack space with optional RPK 005 (single) or RPK 006 (double) Rack Mount Kits | Balanced Audio In: | 3-pin female XLR, accepts microphone, line, 25V or 70V audio input |
| Power: | External power supply, 24VAC, 50 or 60Hz, 2.4VA, 82mA max. current drain | Mic Input: | lo-Z, 100 μ V min. to 50mV max. 1mV nominal, 3k Ω input impedance Supplies simplex power 20V (DIN45296) for condenser mics |
| Modulation: | 95kHz FM, \pm 15kHz deviation, 75 Ω source impedance, 75 μ sec pre-emphasis, | Line Input: | 21mV min. to 10V max., 212mV nominal, 100K Ω input impedance |
| AGC: | Variable slope compressor/limiter | 70 Volt Input: | 216mV min. to 100V max., 2.16V nominal, 100K Ω input impedance |
| Operating Req.: | 0-50°C ambient temperature, non-condensing, non-corrosive atmosphere | Unbalanced Audio Ins: | (2) RCA, 21mV min. to 10V max., 212mV nominal, 50K Ω input impedance |
| Front Panel: | | Input Selector: | 3-position slide-type switch, selects: mic/line/70V on balanced audio input |
| Power Switch: | Two-position rocker, ON/OFF | High-Pass Filter: | 3-position slide-type switch, 20Hz, 175Hz, or 725Hz, 6dB/octave roll-off |
| Power Indicator: | Green LED | Modulation Outputs: | (2) F-type connectors, 75 Ω , 95kHz FM, \pm 15kHz deviation, 0.5V P-P signal uses RG-59 cable, 1000 ft. (304 m) max. CATV splitters cannot be used |
| Audio Indicators: | Amber LED "Ok" for nominal input signal level | Power Connections: | 2-conductor, screw-terminals |
| Red LED "Hi" for excessive input signal level | | Transmitter Type: | For use with Williams Sound WIR TX1, WIR TX2, WIR TX3 Transmitter/Emitter panels. Each MOD 1 Modulator can drive two Transmitter panels directly. For multi-transmitter systems, each TX3 repeats the modulation signal to drive the next transmitter in the chain. |
| Audio Level Control: | Rotary pot, screwdriver adjust, used with audio indicator lights | | |
| Tape Output: | RCA jack, 600mV, 1200 Ω source impedance, 10K Ω nominal load impedance | | |
| Infrared Test LED: | IR LED for receiver testing, monitoring, and audio signal testing | | |

Infrared Transmitter, Model TX3

| | | | |
|---------------------|--|-------------------------|--|
| Dimensions, Weight: | 11.125" (28.3 cm) W x 8.125" (20.6 cm) H x 3.25" (8.3 cm) D, 3.25 lbs. (1.6 kg) | TX3 Front Panel: | |
| Color: | Black epoxy paint with white legends, red acrylic window | Power Indicator: | Red LED, visible in center of window, also indicates 95 kHz signal is present |
| Wall Mount: | Omnidirectional mount included for wall and ceiling mounting. | TX3 Rear Panel: | |
| Tripod Mount: | Optional SS-2 Tripod Stand Kit available | Mounting Holes: | Two sets of threaded holes for use with omnidirectional mount (included) two threaded holes on sides of the cabinet for Tripod Stand Kit |
| Power: | External power supply, 24VAC, 50 or 60Hz, 50VA, 0.9A nom. current drain Transmitter shuts off when modulation signal is not present | Modulation Input: | F-type connector, 75 Ω , 95kHz FM, 0.5V P-P signal from MOD 1 Modulator |
| Operating Req.: | 0-50° C ambient temperature, non-condensing, non-corrosive atmosphere | Modulation Output: | F-type connector, 75 Ω , 95kHz FM, 0.5V P-P signal output to additional TX3 |
| Coverage Area: | 10,000 sq. ft. (930 sq. m), 50° cone pattern, see coverage diagram | Power Connection: | 2-conductor, screw-terminals |
| | | 95 kHz Carrier Cable: | RG-59 Coax, F-connectors |
| | | Power Cable: | NEC Class 2 wiring, 2-conductor, 18 ga. min., 200 foot (61 m) max. length (for 18 ga. wire), each TX3 Transmitter requires its own 24VAC Power Supply. |

